

UHF Antennas + SO

23

BROADCAST NEWS

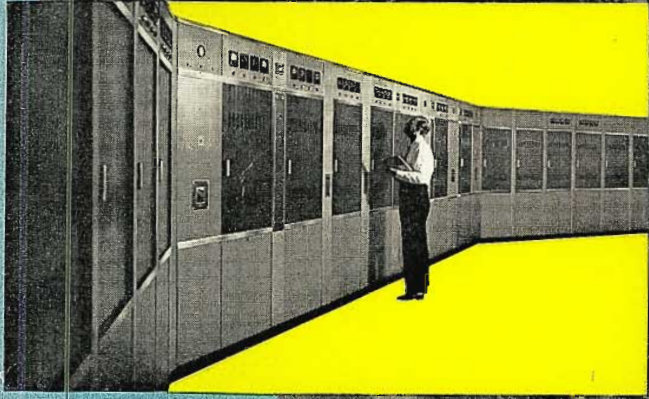
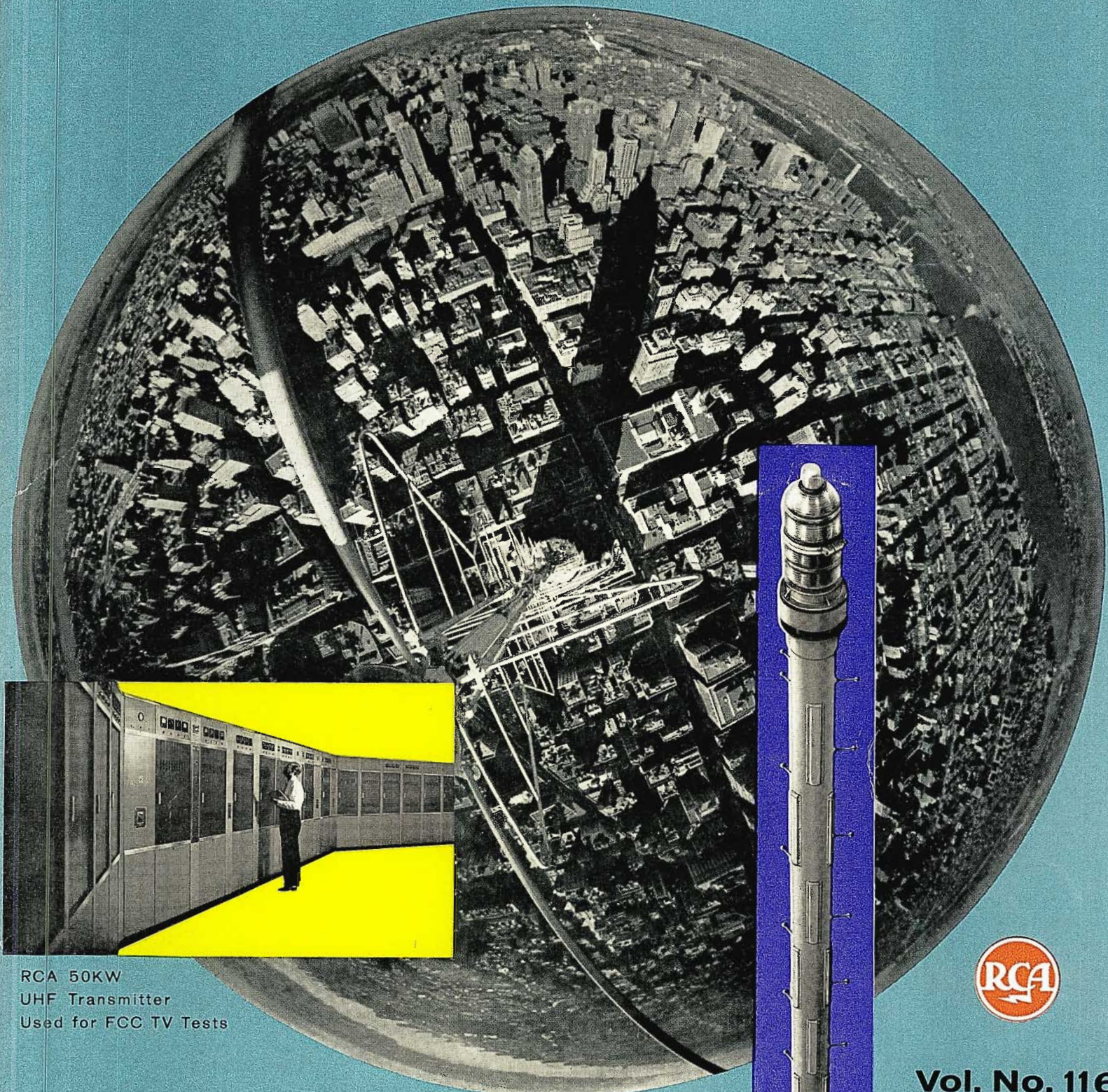

RCA 50KW
UHF Transmitter
Used for FCC TV Tests



Vol. No. 116
FEB. 1963

UHF TESTS IN NEW YORK CITY

TV Camera of the Sixties!

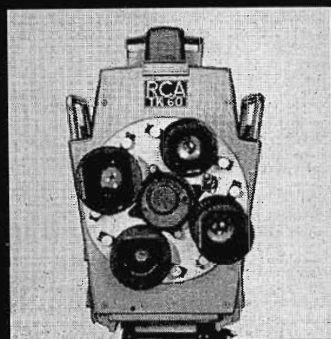
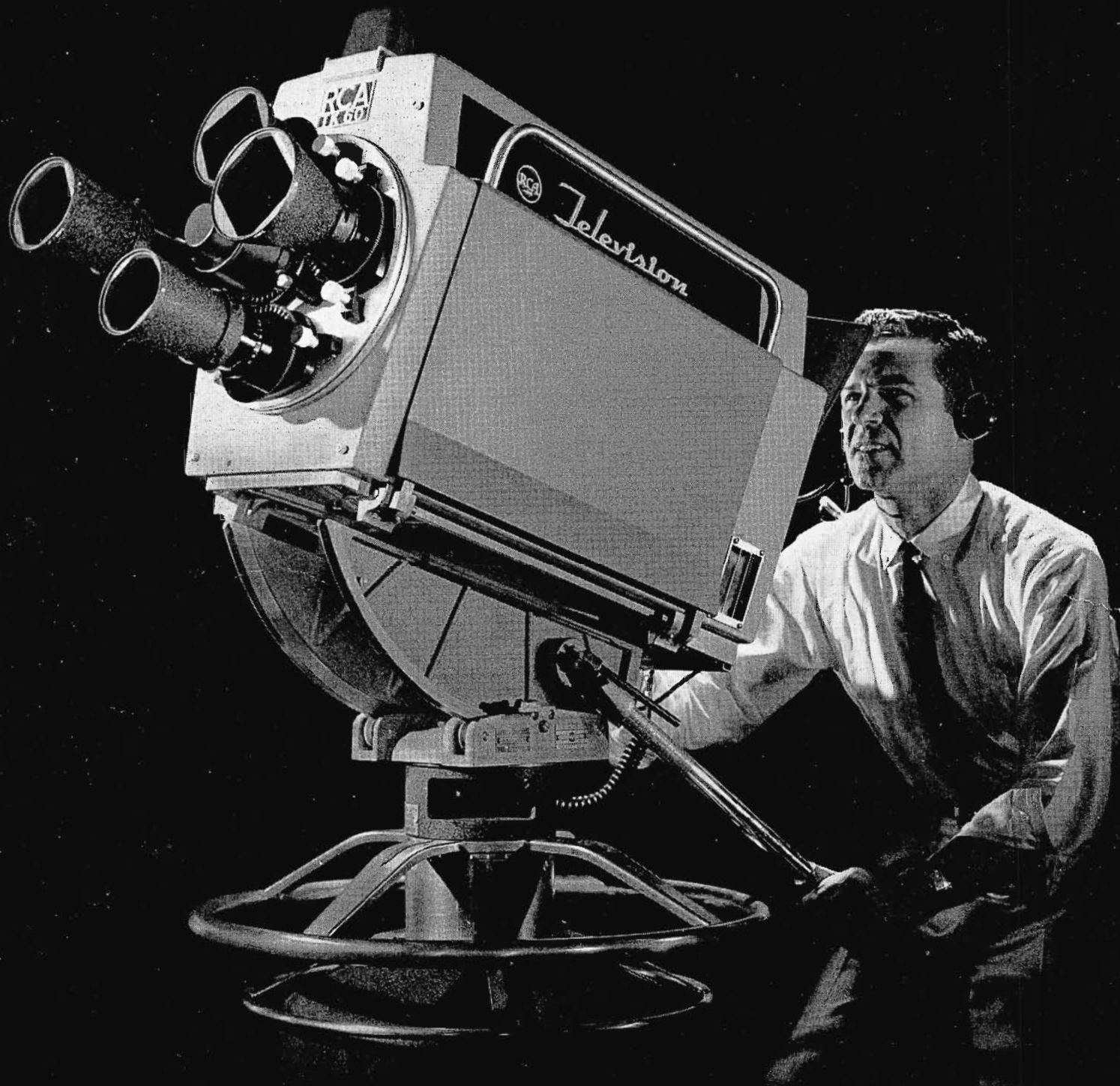

Distinctive silhouette of "TK-60", television studio camera that's years ahead in performance.

After five years of intensive development and two years of field testing, the TK-60 advanced studio TV camera is here! Big picture 4½" image orthicon pickup tube combines with stabilized circuits, ease of camera set-up, and simplicity of operation to make it every inch the TV Camera for the "sixties". Here's a great new monochrome camera that's sure to be a success with producers and station-men alike! The TK-60 produces pictures of sensationally new quality...over extended periods, without alignment delays. You can control contrast and mood as never before. You can produce tapes and live commercials that show the client's product in sparkling, life-like detail, with effects not possible on any other camera. Where striking picture quality can mean stepped-up product sales, this is the camera that "says it" and "sells it" best! See the RCA Broadcast Representative for the complete story Or write RCA Broadcast and Television Equipment, Building 15-5, Camden, N. J.



THE MOST TRUSTED NAME IN TELEVISION

BROADCAST NEWS

published by

RADIO CORPORATION OF AMERICA

BROADCAST & COMMUNICATIONS PRODUCTS DIVISION, CAMDEN, N. J.

issued quarterly

PRICE in U.S.A. - - - - - \$4.00 for 4 issues
outside U.S.A. - - - \$5.00 for 4 issues

C O N T E N T S

	Page
COMPARATIVE STUDY OF VHF AND UHF TELEVISION	6
MEGAWATT UHF TEST STATION	21
MTV PIONEER BLENDS CULTURE AND CIVICS FOR GOTHAM VIEWERS	26
SELECTING THE UHF TELEVISION ANTENNA	30
WBOC-TV POWER INCREASE PACES STEADY GROWTH IN UHF	38
MILWAUKEE ETV USES BOTH VHF AND UHF	45
TEN YEARS OF COMMERCIAL UHF AT WBRE-TV	56
1-KW UHF TRANSMITTER	64
12.5 AND 25-KW UHF TRANSMITTERS	66
50-KW UHF TRANSMITTER	68

As We Were Saying

OUR COVER, this issue, may take a little explaining. That round and shimmering ball is not the reflector of a new satellite—nor the view from one. On the contrary it is the earth-bound (more or less) view from the top of the Empire State antenna as seen through the "eye" of a 180-degree camera (for how it was taken see next page).

Why did we feature it on this cover? Well, partly because we've been waiting a long time

for an excuse to use what we think is one of the most intriguing pictures ever taken by a radio engineer. But, more particularly, because we thought it helped tell a story.

This issue, as you will soon note, is mostly about UHF—and the lead article describes the results of a survey made by RCA engineers during the New York UHF-TV Project of the FCC. We wanted a cover illustration which would "tie-in" with, or symbolize, the contents of the

issue. The 180-degree photograph shows the area which a UHF antenna on the Empire State "sees"—and what a UHF antenna sees, is what a UHF antenna gets (multi-path and noise permitting). If the horizon in the photograph is a little blurry—well, you know "like UHF."

To get in a "commercial" we inset pictures of the RCA 50 KW UHF Transmitter used in the FCC tests, and the RCA UHF Pylon Antenna. The latter is not the antenna used in the tests, but it is the antenna most new UHF stations will use and, therefore, (from our view) more to the point.

IT'S NOT A BIRD, it's not an airplane, it's not superman—it's just our boy John Dearing (photo left) making like a bird to take the picture on the cover. Actually he did it about ten years ago—at the time the present main antenna structure was erected. He was one of the RCA engineers supervising the installation—and he made the dizzying climb to the top many times. To take the picture on the cover he straddled the lightning rod prongs above the beacon light, and bent over almost horizontal to point the camera straight down. In fact he leaned so far over that in one shot (see below) both his head and feet came into the view of the super-wide-angle lens.

Left—John Dearing, RCA engineer, balancing himself on the lightning rod prongs above the Empire State antenna to take the 360-degree picture shown on the cover of this issue.

Below—For some of the shots John took he bent over so far that both his head (lower left) and his leg and foot (center right) came into the view of the 360-degree camera.

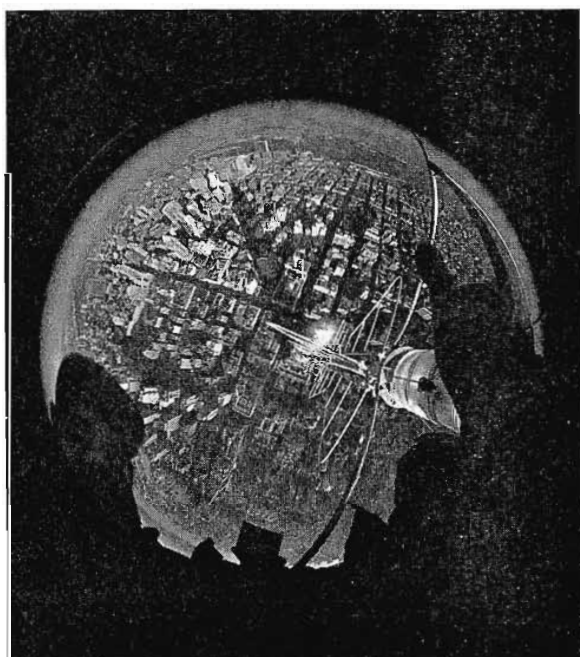

IT IS A SCOOP of sorts—the article (Page 6) by Peterson comparing Low VHF, High VHF and UHF in New York. It reports the results of a study made by RCA engineers during the recent UHF tests (of the FCC) in the New York area. The RCA study was an independent endeavor completely separate from the official survey directed by the FCC staff. It was designed to provide RCA engineers with certain specific information which they wanted to "fill-in" their knowledge of UHF broadcasting potential.

The results of the FCC's study were described by Jules Dietz of the FCC's engineering staff at the Fall Meeting of the EIA—and were documented in a report issued simultaneously by the FCC. Because of the resurgence of interest in UHF this report has been widely discussed and variously interpreted.

The results of the RCA study are reported "for the first time anywhere" in the Peterson article in this issue. While the objectives and scope of the RCA study were more limited than those of the official study, the results should be of great interest to broadcast engineers concerned with UHF problems.

FREQUENCY DEPENDENCE OF PICTURE DEGRADATION resulting from multi-path propagation and the transmission loss in highly built-up and variable areas like those east and west of Central Park in New York City. Read quickly this sounds like gobbledegook. It's not. It's a carefully considered and precise statement of the very specific objectives of the RCA study described by Peterson. But it is written in engineeringese—and as such perhaps bears translating for us lesser mortals.

As Peterson points out in the introduction to his report, most of the factors determining relative UHF performance have been investigated before, in depth—first by RCA engineers in the thirties and forties, and, more recently, by TASO. But, while these earlier studies provided a wealth of information on propagation, per se, they did not fully answer the questions of **what happens to the picture** in an area such as Manhattan.

The New York UHF Project provided an opportunity for side-by-side comparison of UHF pictures with low and high-band VHF pictures. Mr. Peterson and an RCA crew made such comparisons at more than 200 points. Their evaluations of picture quality as seen on the receiver were aided by simultaneous observation of pulse signals and (for color) of the multi-burst signal. The results are reported with a calmness and detachment which are notable in the midst of the present fray. While statisticians may question the size and randomness of the sample, we believe that engineers who study this report will be convinced of its adequacy.

In any event not much more will be known on this subject until a UHF station has been in opera-



Special issue of BROADCAST NEWS, dated October 1952, heralded advent of KPTV, the first commercial UHF television station. Above (left) is shown the cover and (right) the lead pages of the feature story which reported early results.

As We Were Saying

tion in New York for an extended period. By then better UHF receivers, and perhaps new types of antenna systems, will be available. The final evaluation will be made, not by the field intensity meter or the scope, but by the cash register.

CONTINUANCE OF UHF in New York City has been assured by the transfer of the Channel 31 facilities (used in the FCC tests) to the City of New York, which will operate the station as WNYC-TV, (see story, Page 26). It is the first "municipal" TV station and, as Seymour Siegel points out, it will be neither "commercial" nor "educational," but rather will introduce an entirely new concept in TV programming. It's an interesting development—quite aside from the fact that it provides a continuing proving ground for the further development of UHF.

UHF REVISITED: Thirty years ago F. Scott Fitzgerald wrote a short story entitled **Babylon Revisited**. Critics consider it one of his best. Gist of the story: Babylon, revisited . . . is still Babylon.

Ten years ago we wrote a story on UHF in Portland (BROADCAST NEWS, No. 71, September-October 1952). Just three months before, the FCC had opened the UHF band for commercial TV, and KPTV, Portland had just gone on the air. It was the world's first commercial UHF TV station. It was the first—and, for awhile, the only—TV station in the area. The populace was entranced—and so were we.

We spent a week surveying (with field strength meter and receiver) the reception of KPTV

throughout the Portland area. We wrote it up carefully, albeit enthusiastically, in the article mentioned above.

With the resurgence of interest in UHF—and the flood of new discussion—we thought it would be interesting to check on what we said ten years ago. So we carefully re-read the story on KPTV. And we decided that in so far as technical performance is concerned, we wouldn't change a word if we were rewriting it today. We said then that UHF worked well in flat terrain, that there were shadows behind elevations, that there might be multi-path problems, that lack of good UHF receivers . . . "caused some trouble." All of which we would say today—with about the same emphasis.

So what happened? KPTV was a technical **and a commercial** success—for awhile. Then three v's came to Portland. You know the rest.

BUT IT WILL WORK as WBRE-TV in Wilkes-Barre has proved (see "Ten Years of Commercial UHF Operation at WBRE-TV" starting on Page 56). What is the secret of WBRE's success (all the more remarkable because it is located in an area of very rough terrain)? Well, for one thing, height—the antenna is on a 380-foot tower which stands on a 2100-foot mountain. For another, power—a 25 KW transmitter with a 46-gain antenna provides an effective radiated power of one million watts. For a third, an efficient and very progressive operation (see below). And finally, of course, there is the fact that WBRE's competition is all U!

*As We Were
Saying*

THE HABIT OF BEING FIRST has been "a way of business" at WBRE since the station was established, nearly forty years ago. Way back in 1934 BROADCAST NEWS described WBRE's new (and for that time very modern) studios—which featured live-end-dead-end construction (see illustration left) and the then brand-new velocity microphone. Over the years since, there have been four more BROADCAST NEWS stories on WBRE, and there could have been more.

As the article (Page 56) points out, WBRE's record of pioneering in UHF is unmatched. It includes the first RCA 1 KW UHF, the first RCA 12 KW UHF and first RCA 25 KW UHF—and it was the first TV station anywhere with a million watts ERP. WBRE also installed the first RCA automation "station-break" equipment. They were the first in their area with live and film color cameras and, just recently, they installed two of the new RCA TR-22 Tape Recorders. For a station in the 27th Market, they really move!

WBRE's driving power is a unique father-son combination which has been active in radio for half a century. Louis Baltimore became interested in ham radio in 1913, while still in high school. In 1924, he founded WBRE—building the station from a small beginning to a position of power and prestige. In 1945, his son David joined him in the business, gradually took over the reins, and in 1950, became General Manager. Under his direction WBRE added FM then TV—went on to become one of the nation's outstanding stations.

ALSO TRUE IN '62. About this time last year we noted that in 1961 broadcast stations in the United States bought more RCA television tape recorders than any other make. We are happy to report now that this was also true in 1962. In general, the recorders ordered in '62 were higher-priced, came with more extras, included more equipped for color.

The terrific success of our deluxe model TR-22 (we're swamped with orders) guarantees that this will also be true in 1963. We believe it's a significant trend—and not hard to explain. Tape recording has become an integral part of the operation of nearly all stations—and an important factor at the till for most. Broadcasters have always been ready to buy equipment that helped the business—and most think it's good business to buy the best.

THE TK-60's ARE SOARING, just as we hoped they would. We started shipping the TK-60—which is the newest model of our 4½-inch I.O. Camera—back in November. The first units have been out long enough for us to uncross our fingers. We now know for sure that we have a really hot item—a camera in the same class as our TR-22 Recorder.

HISTORY LESSON: Throughout history, the trademark has been recognized both as a stamp of identification and as an incentive to quality.

In ancient Egypt, a slave put his own mark on every brick so that the slave-master knew whom to punish if one was defective. Soap makers in Rome received stiff fines and were prevented from doing business if their products were unbranded. Flemish tapestry workers who failed to mark their products lost their right hands. In 1266, England passed a law requiring bakers to mark each loaf so that if a bad one turned up, "it will be knowne in whom the faulte lies."

More recently the Soviet Union decided that trademarks, although a foundation of free enterprise, must be made part of the Communist economy. Apparently the Government found that its "no-name firms" were turning out poor products, in spite of constant inspection. Entire industrial groups were producing shoddy wares. Lack of identity resulted in lack of incentive, and was clearly responsible for lack of quality.

Consequently, to distinguish one state-owned firm from another, the Government first gave each a name. It then required many firms to identify their products with a trademark. "The trademark," explained V. A. Nikiforov, a Soviet economist, "makes it possible for the consumer to select the goods which he likes . . . This forces other firms to undertake measures to improve the quality of their own product in harmony with the demands of the consumer. Thus the trademark promotes the drive for raising the quality of production."

Professor Marshall I. Goldman of Wellesley College, in a recent article on trademarks in the Soviet Union, reported that Russia is hoping by 1965 to have some 30 to 40 different brands of radios and phonographs and about 20 types of television sets.

* * * *

The above lesson in history is quoted from "Commentary," a publication of Smith Kline & French Laboratories—another great company that believes its trademark to be a true **mark of quality**.



This is the lead page of the first BROADCAST NEWS story on WBRE. It appeared in the February 1934 issue.

MERRILL TRAINER NAMED as Manager, Broadcast Studio Merchandising and Engineering Department, RCA Broadcast & Communications Products Division. In his new capacity, Mr. Trainer will direct engineering and merchandising activities for the Division's line of cameras, tape recorders, switching systems and other equipment used in radio and television broadcasting stations . . . etc., etc. So runs the press release and so the story will read in the trade journals. But not here!

One of the nice things about this column is that we're not bound by the language and syntax of officialese. We can write it just like a letter to the folks back on the farm. Moreover, if we feel a bit of enthusiasm, we can show it. And, because most of those we write about are old friends, this is frequent.

Take this announcement about Merrill. It says, "Mr. Trainer has been an engineering and marketing executive in the broadcast equipment field for more than 30 years." The truth is, this June will mark his 36th year—and we have a photo to prove it (see below). And, as for the "executive" bit, everyone in the industry knows that, at one time or another, Merrill has held almost every job there is in the Broadcast Division.

The release goes on to say that, "He joined RCA in 1930, and subsequently played an important part in development work leading to the present all-electronic television system." Seldom has so little been said of so much. Merrill "came in" during the mechanical scanning days of TV. He was one of the small group who worked on tele-

vision under the direction of Dr. Alexanderson at Schenectady from 1927 to 1930. When the activity moved to Camden in 1930, he came along—and during the thirties he was an active participant in all of the early RCA television "field tests."

During the war he was manager of the group that designed the camera and transmitter for the famous "BLOCK" equipment—the first TV-equipped aerial bomb. After the war this group became RCA's Television Studio Engineering Section. Under Merrill's direction they designed the TK-10 Camera and all the associated gear used with it—and did such a good job that second-generation models of this camera (and "chinese" copies) still make up the great majority of all the equipment used in U.S. television stations.

In 1947, Merrill left engineering (or so he thought) to become Manager of RCA Television Equipment Sales. In the fifteen years since then he has held a succession of jobs—and most of them have included some responsibility for product engineering. He has been, among other things: Product Manager (for all broadcast equipment); Manager of the TV Tape Recording Department; Manager, Color Coordination; and Manager, International Sales Liaison. His new assignment wraps up most of the responsibilities of these previous jobs—plus direct responsibility for all TV Tape, Studio Equipment, and Electron Microscope engineering.

Probably no one has been longer, or more closely, connected with the development of television broadcasting than Merrill. And with his widespread acquaintance, his convivial spirit and his always-willingness to help, no one in the equipment end of the business is better known or liked. His appointment will be widely applauded by his multitude of friends—and we want to be in that company.



Merrill A. Trainer, newly appointed Manager, Broadcast Studio Merchandising and Engineering Department, RCA Broadcast & Communications Products Division.

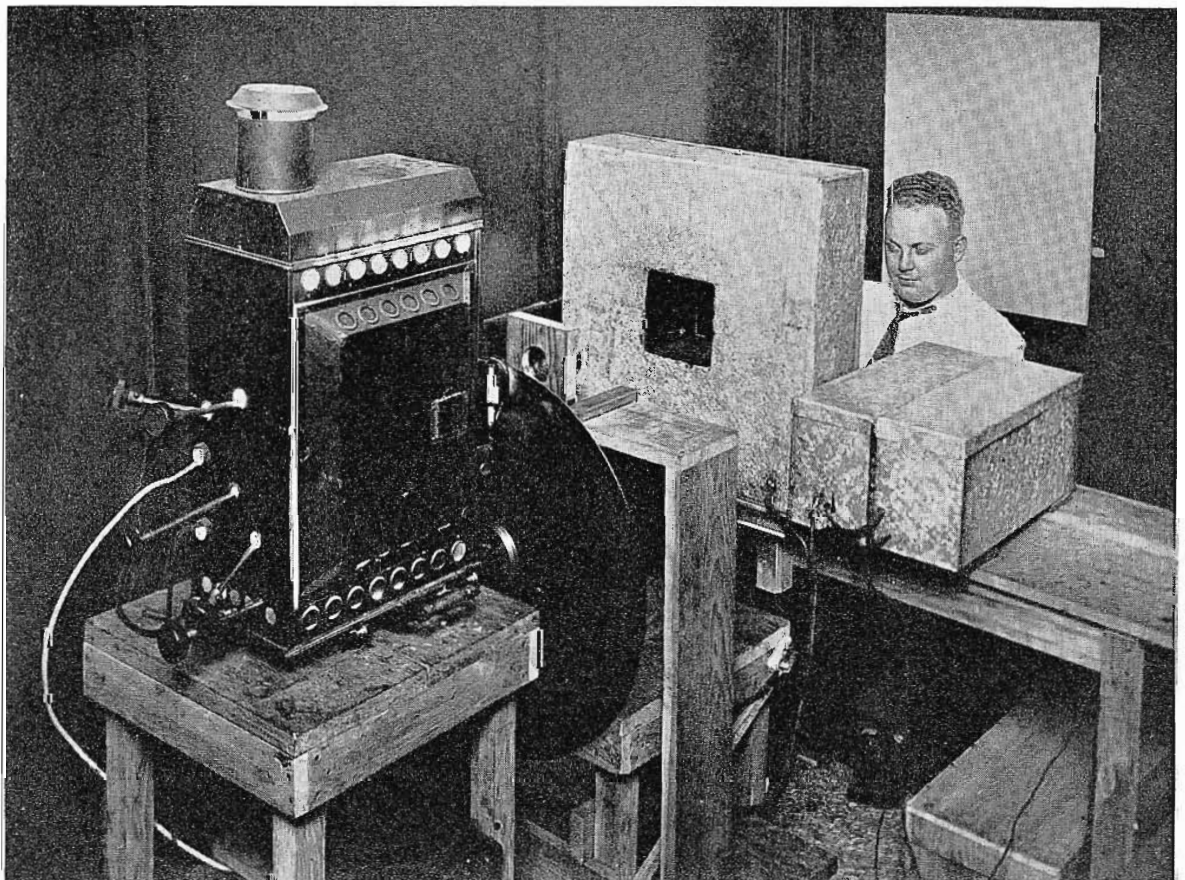

Photograph made on October 21, 1927, shows Merrill Trainer in front of early television scanning equipment. Arc lamp at left furnished high-intensity light which spirally arranged holes in Nipkow disc caused to scan performer's face. Photo cells on far side of the square doughnut (facing performer) picked up light reflected from performer's face and converted this to video signal.

COMPARATIVE STUDY OF LOW VHF, HIGH VHF, AND UHF TELEVISION BROADCASTING IN NEW YORK AREA

by DONALD W. PETERSON
Radio Corporation of America

A substantial part of the UHF television spectrum (470-890 mc) remains unused in the United States.¹ Technical differences between VHF and UHF system performance are to a degree responsible for this situation.

The most conspicuous VHF-UHF difference is one which favors the VHF end of the spectrum; the shadow loss from hills increases with frequency. Another difference, less commonly observed in operating systems, is the apparent theoretical advantage of UHF propagation over very smooth terrain. When the terrain is smooth enough to produce interference lobing, the field strength (for a given radiated power) at normal receiving antenna heights increases with frequency throughout a considerable distance range. There are fundamental receiving antenna problems which tend to adversely affect system performance in cluttered surroundings. A number of state-of-the-art differences in r-f hardware exist and currently are important factors in relative system performance over the spectrum. The most serious of these is the substantial difference, favoring the lower end of the TV spectrum, in receiver noise figure. In

addition, galactic noise is received at a high enough level to establish a limitation substantially higher than thermal noise for the lowest VHF channels. UHF system noise performance could eventually surpass low VHF performance in view of this fact although the necessity for low receiver cost makes this seem unlikely. Finally, in this summary of frequency-dependent differences, there is the practice of using much higher gain transmitting antennas for UHF than for VHF. Adoption of this expedient was necessary for UHF but there are objectionable consequences for UHF systems, particularly in hilly or rising terrain.

A long series of studies of the propagation problems and extensive advances of the hardware art culminated in the Television Allocations Study Organization (TASO) studies reported in 1959.² This large cooperative undertaking of government and industry answered most of the remaining questions about frequency dependence.

One problem area has been slighted because of the costliness of an effective study. Up to 1962 there had been no comprehensive comparison of VHF and UHF tele-

vision in a highly built-up city. In view of the dominant part that large cities, and New York City in particular, play in American TV, this remaining problem was serious enough to merit study.

Federal Communications Commission New York UHF Project

The Federal Communications Commission obtained from the 86th Congress a two-million-dollar appropriation for the necessary instrumentation, field testing, and data analysis to study large-city TV problems. The FCC planned to conduct a large-scale field survey in the New York City area^{3,4} during late 1961 and 1962.

A channel 31 (572-578 mc) transmitter was leased from RCA, installed on the 80th floor of the Empire State Building, and operated by the City of New York. A Melpar developed omni-directional antenna was interspersed between layers of the CBS antenna on the tower above the Empire State Building. Jerrold Electronics Corporation was engaged to do the field testing using RCA receivers and a portable all-channel field strength meter developed by Smith Electronics. The UHF broadcasting system, with the call letters WUHF, was put into operation in November 1961, thus affording an opportunity to perform comparative studies of UHF and VHF stations in and around the city.

RCA participated during 1960-61 in several industry committees set up by the FCC to advise the Commission and help plan the New York City project.

TABLE I
Clutter Situations Studied in New York City

Location	Roof	Room	Street	Character of Sample	Type of Sampling
Manhattan	x	x		Extremely varied building sizes	Random
Forest Hills	x	x		Moderately varied building sizes	Random
Forest Hills		x	x	Six story apartments	Random
Forest Hills			x	Two story row houses	Periodic
Forest Hills			x	Two story single houses	Periodic

¹ TV Fact Book 32, 1962. Addenda of January 6, 1962, shows five times as many VHF stations in operation with only about one sixth as many channels as there are for UHF.

² Television Allocations Study Organization Report: "Engineering Aspects of Television Allocations," March 1959.

³ "New York UHF-TV project of the FCC." A. G. Skrivseth, IRE Trans. on Broadcasting, December 1961, pp. 24-26.

⁴ A preliminary report on the FCC New York UHF Project appears in the 1962 New York IRE Convention Record.



FIG. 1. Manhattan between 85th Street and 60th Street, illustrating the degree of clutter in the Central Park area.

An RCA UHF Project is Planned

Starting long before the inception of American TV broadcasting in the mid-forties, RCA has contributed in many ways to the advancing r-f hardware art and has performed numerous propagation⁵ and system studies. In view of the availability of the FCC facilities, an RCA field project in the New York City area was planned late in 1960 in the belief that the knowledge gained could supplement the output of the FCC project.

The objectives of the RCA project will be stated. The principal unknown factor was the question of propagation effects in the clutter of highly built-up portions of the city, the large-building areas. The study was to determine the frequency dependence of the picture degradation resulting from multipath propagation and the transmission loss in highly built-up and variable areas like those east and west of Central Park in New York City. The degradation of *color* pictures from multipath propagation was of particular interest.

The addition of a UHF system on the Empire State Building provided an opportunity to examine any kind of frequency dependence in an entire service area under

true broadcasting conditions. With more radiated power and better receivers and field strength meters available than for earlier New York surveys, radial surveys outside the city could be carried out more completely than previously.

The problems of the comparative study can be divided into two categories: (1) smooth terrain problems and (2) rough terrain problems. Broadly speaking there are two basic kinds of propagation problems in both categories. Both buildings and hills cause multipath propagation with resultant picture degradation. They also produce distorted field distributions and shadow loss both of which tend to reduce the space median of antenna terminal voltages. It is here assumed that UHF antennas of interest will have aperture dimensions in the order of several wavelengths. Buildings also introduce attenuation since propagation must sometimes be through walls. In the smooth terrain built-up city situation the receiving antennas are figuratively immersed in a sea of clutter with little or no possibility of using antenna directivity or gain in a predictable way, if the building heights are variable. In the rural hilly terrain situation the propagation effects may be qualitatively understood by inspection of the surroundings. The consequences of terrain shadowing may reach dominating proportions. Ultimately, all kinds of situations are of interest but to enable holding the project to manageable proportions,

clutter effects were studied in smooth terrain and rough terrain effects were studied with clutter eliminated.

Smooth Terrain Problems

The clutter of New York City ranges from the extreme variation of building sizes of Manhattan, illustrated in Fig. 1, to the slight variation of two story rowhouses in Queens and Brooklyn. The situations studied in New York City are shown in Table I. In all of these situations it was necessary to determine both the multipath picture degradation and the receiver terminal voltage.

The distance to fringe area cities in smooth terrain was desired. Since the clutter effects on picture quality (multipath degradation) were to be determined in New York City, it was necessary to measure only field strength above roof-top level. A radial line along the south shore of Long Island was chosen for a survey over exceptionally smooth terrain with suburban clutter. The distance of the fringe area, particularly for UHF, depends upon the receiving antenna gain which can be effectively employed, so effective receiving antenna gain in clutter is of interest too.

Rough Terrain Problems

The extent to which rough terrain problems can be studied in the New York area is quite limited. The two Watchung ranges in New Jersey afford what is probably the

⁵ Comparative propagation measurements; television transmitters at 67.25, 288, 510, and 910 megacycles," G. H. Brown, J. Epstein and D. W. Peterson, RCA Review, June 1948, pp. 177-202.

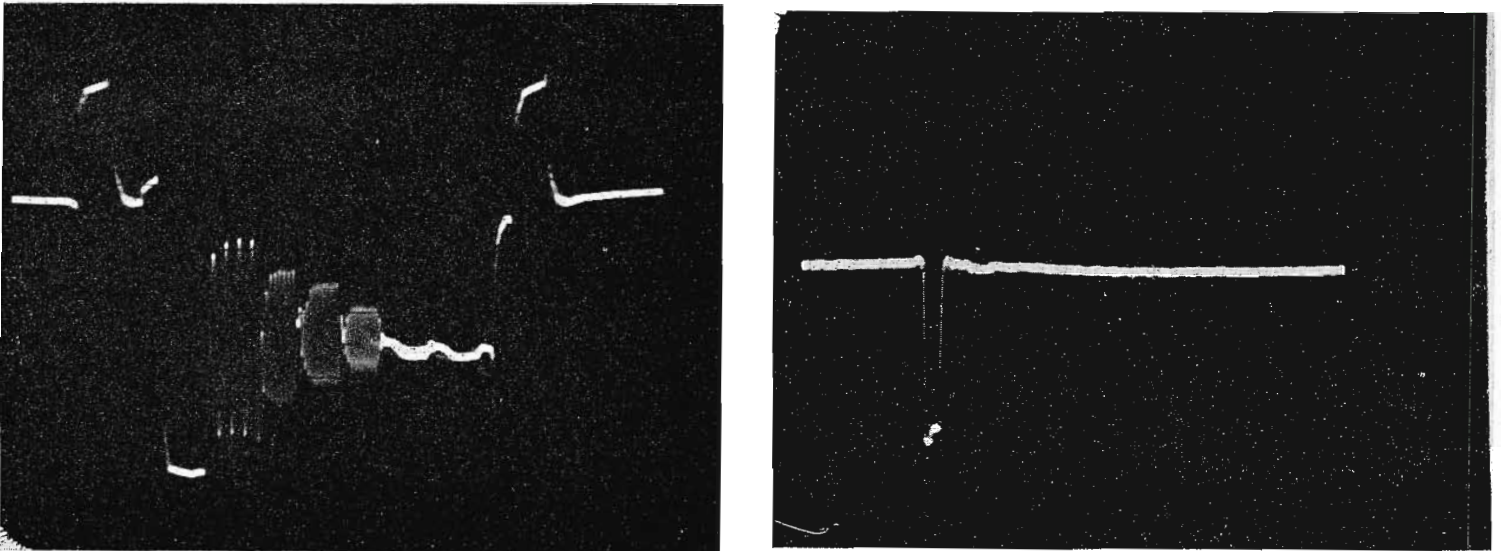

FIG. 2. Test waveforms (multi-burst, left, and equalizing pulse, right) which were displayed on oscilloscope and photographed to aid in picture evaluation.

best topographic situation for studying terrain effects. The shadow loss from these ranges was too great to enable complete measurement of field strength with the radiated power and instrumentation available for the 1948 tests.⁵ It was therefore desirable in the current project to include a survey along a radial line through the Watchungs. The topography is relatively simple and the mountain ranges are only 14 and 15.5 miles from the Empire State Building.

Conditions of the Field Test

Low VHF channel 2 and high VHF channel 7 stations were chosen by the FCC as the most suitable broadcasting systems for comparison with the channel 31 system; the same channels were also used for the RCA comparison. All three transmitting plants delivered field strengths within a radius of about two miles which were commonly excessive for standard receivers and transmission lines. It was quite usual for the stray pick-up of a standard receiver to exceed the signal level from the antenna. As a consequence, antenna orientation was relatively ineffective in reducing multipath degradation. Special receiver and transmission line shielding was found to be necessary to avoid stray pick-up and was employed successfully. Color programming was available from the channel 4 station directly and via channel 31 so these channels were used for color comparisons.

It was necessary to use regular program material for subjective evaluations of picture quality. This meant that the evaluator could not know the picture quality as transmitted; and this was variable enough to be disturbing. Experience with subjective evaluation in Manhattan, where picture quality is notoriously poor, led to a recognition of further problems: (1) If the picture defect consisted of lack of resolution, there was a marked tendency for picture quality judgments to depend upon the amount of information in the picture. For example, a close-up of a person might appear to have satisfactory resolution while printed matter, say, in a commercial might not be legible or a crowd scene might be quite unsatisfactory. (2) If the picture defect consisted of ghost images, these were found to be quite objectionable in some

scenes and not even noticeable in others under identical receiving conditions. (3) It was often not at all obvious just what was wrong with poor pictures. It was concluded that a picture evaluator in the field could probably benefit by the use of special test waveforms viewed on an oscilloscope.

Test Signals

The difficulty of making reliable subjective evaluations was substantially alleviated by employing two kinds of test signals. The first of these, a part of the standard synchronizing waveform known as the equalizing pulse, is a two microsecond pulse which proved to be useful in observing multipath echo waveforms. The second test signal used is a succession of video modulating bursts ranging from 0.5 to 3.58 mc/sec. and occurring along a picture line. Since this multi-burst can be put on only a picture line or two during regular broadcasting, it must be observed with a line selector oscilloscope. Both test signal waveforms are directly related to picture quality. Their value increased as the picture evaluator gained experience in evaluation with help from these waveform aids.

Both the equalizing pulse and the multi-burst test signals were displayed on an oscilloscope and photographed as a part of most of the RCA field observations made in New York City. Their use eliminated most of the doubts experienced in picture evaluation. Photographs of the test waveforms are shown in Fig. 2.

Transmitting and Receiving Antennas

The transmitting antenna elevations on Empire State Building are shown in Fig. 3. The transmitting antenna azimuth patterns are shown in Fig. 4. The geographical

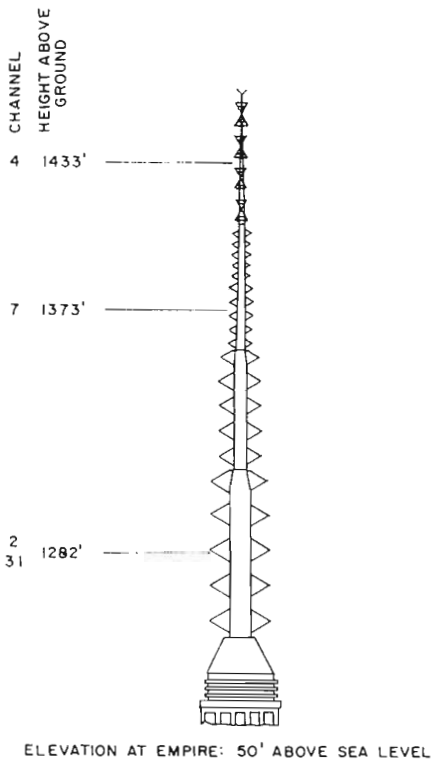

FIG. 3 EMPIRE STATE ANTENNA TOWER

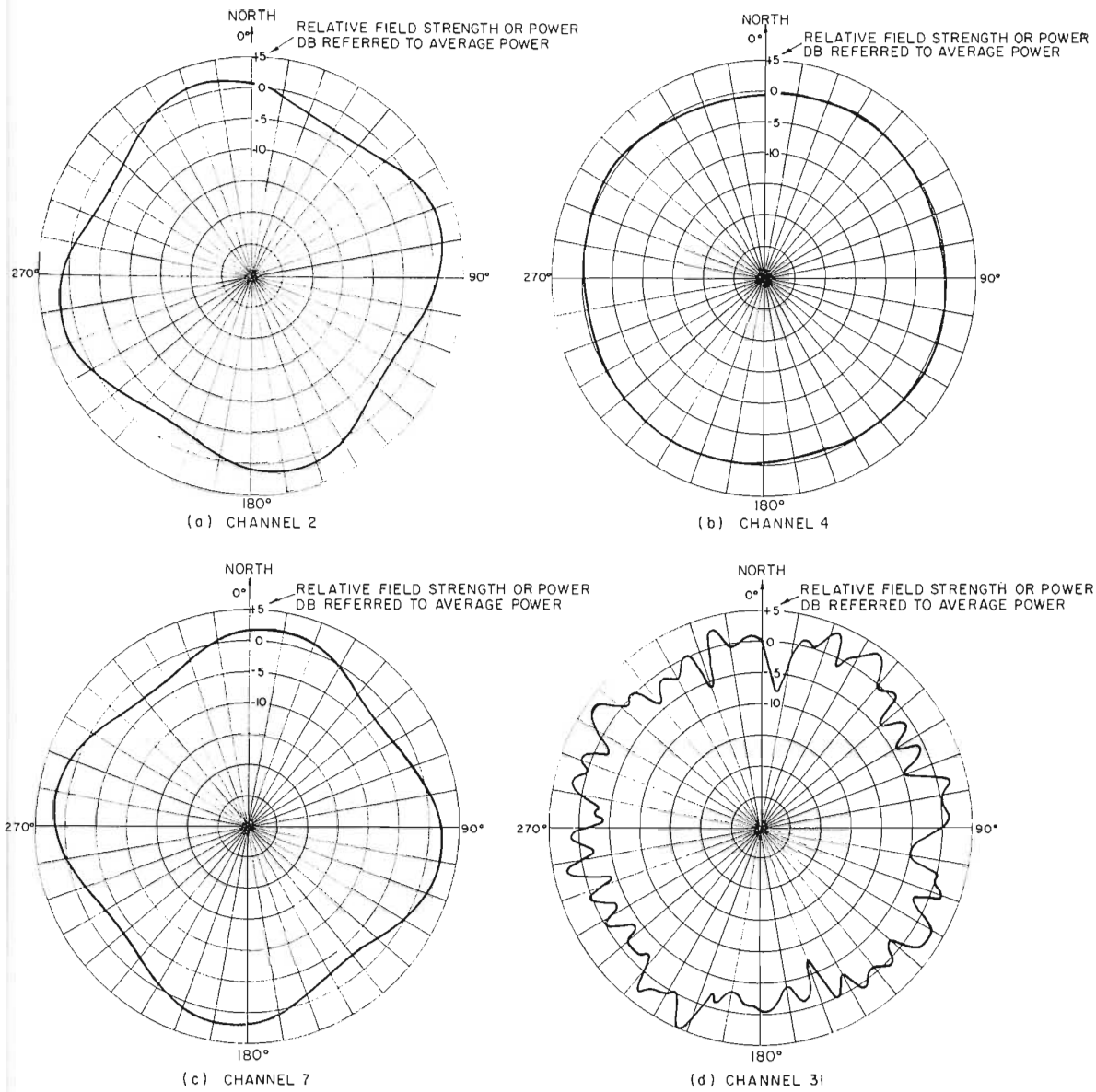

FIG. 4 TRANSMITTING ANTENNA AZIMUTH PATTERNS

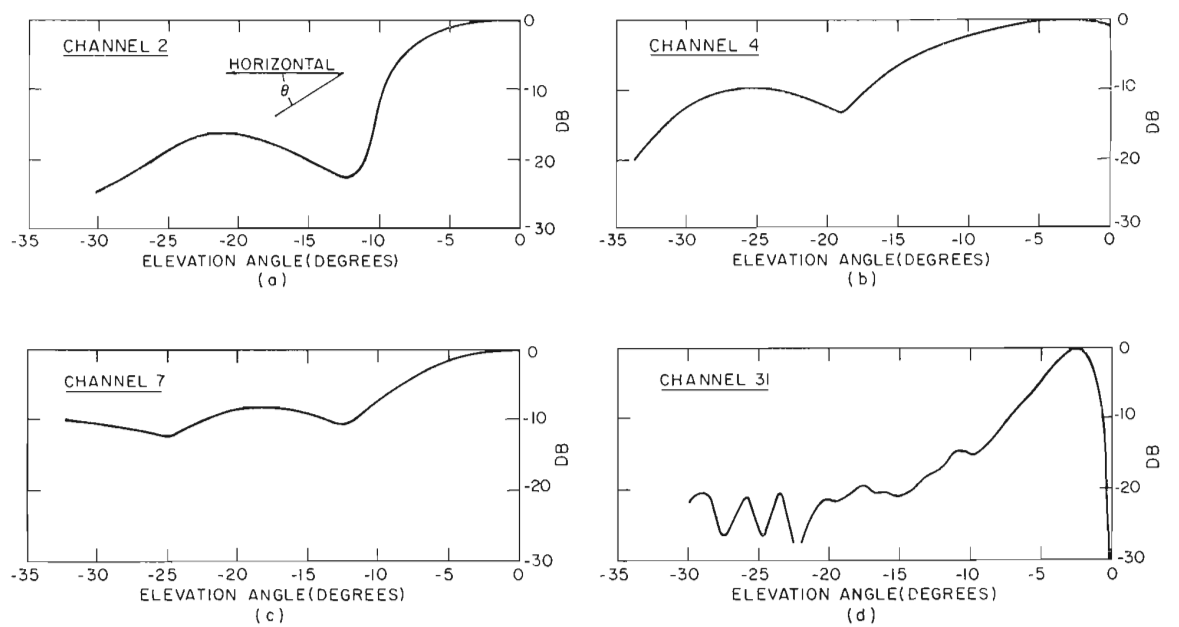

FIG. 5. TRANSMITTING ANTENNA ELEVATION PATTERNS. ORDINATE IS RELATIVE POWER IN DB REFERRED TO AVERAGE POWER ON ELEVATION PATTERN MAXIMUM.

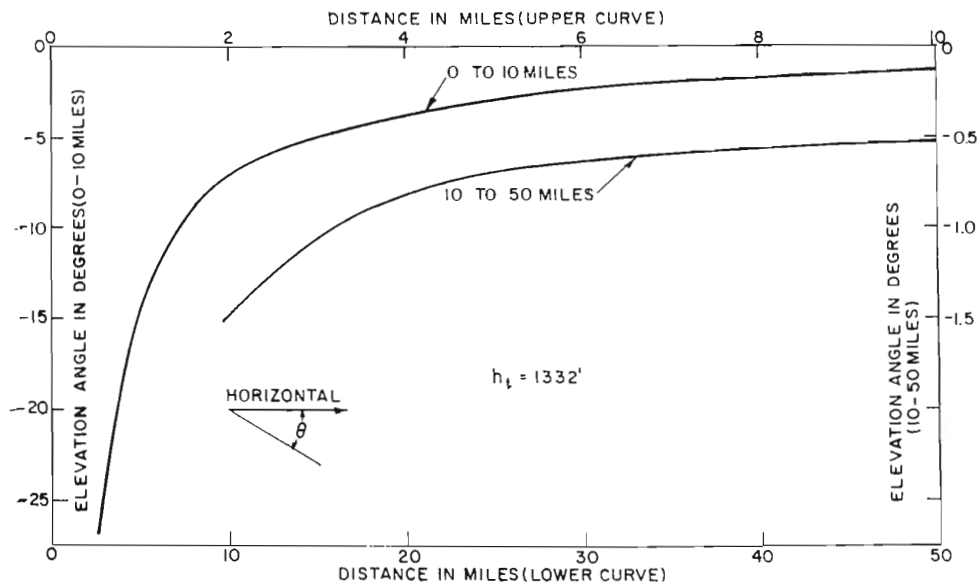

FIG. 6 DIRECT RAY ELEVATION ANGLE AT TRANSMITTING ANTENNA OVER SMOOTH, SPHERICAL EARTH

orientations of the channels 2, 4, and 7 patterns are known and hence could be taken into account in computing theoretical field strengths. The orientation of the channel 31 pattern was not known so there is an approximate +4 to -8 db uncertainty in all UHF computations of theoretical field strength. To put this another way, the radiated power probably lies between 4 db above and 8 db below the nominal (average) value and varies with azimuth angle in an unpredictable manner.

The elevation patterns of the transmitting antennas are shown in Fig. 5. It should be noted that the VHF patterns have deeper minima than the channel 31 patterns from the pattern maximum down to -20°. The portions of the service area served by the elevation pattern minima may be seen by reference to Fig. 6. These minima serve distances of about 1.25, 0.8, and 1.2 miles for channels 2, 4, and 7 respectively. The UHF elevation pattern has been shaped to yield constant field strength with distance over "average" terrain for the FCC F(50, 50) propagation curves.⁶ Because of the necessity of using high UHF antenna gain, the pattern drops rapidly from a maximum at -2.5° as zero elevation angle is approached. This, it will be seen later, has important consequences in hilly and rising terrain.

The outdoor receiving antenna azimuth patterns are shown in Fig. 7. The antennas used were chosen as approximately encompassing the practical range of usable physical sizes. Simplicity of structure and clean patterns were influencing factors in the specific choices. A large and a small antenna were used for each frequency. VHF antennas are in such wide use as to establish the norm for size. On this basis an all-channel unidirectional VHF antenna, the Channel Master TW5, was chosen for the large VHF antenna. The small VHF antennas were single channel dipoles with a parasitic reflector. The small unidirectional UHF antenna was a Channel Master corner reflector type and the large one was a Channel Master 6-foot paraboloid. The unidirectional receiving antenna gains are shown in Table II.

The VHF unidirectional and the UHF corner reflector antennas have similar patterns. The VHF unidirectional and the UHF paraboloid antennas are comparable in physical size and mechanical complexity.

⁶ Sixth Report and Order of the FCC (52-294) published by TV Digest, April 1952. A revision of the VHF propagation curves was recommended to the FCC by the Radio Propagation Advisory Committee.

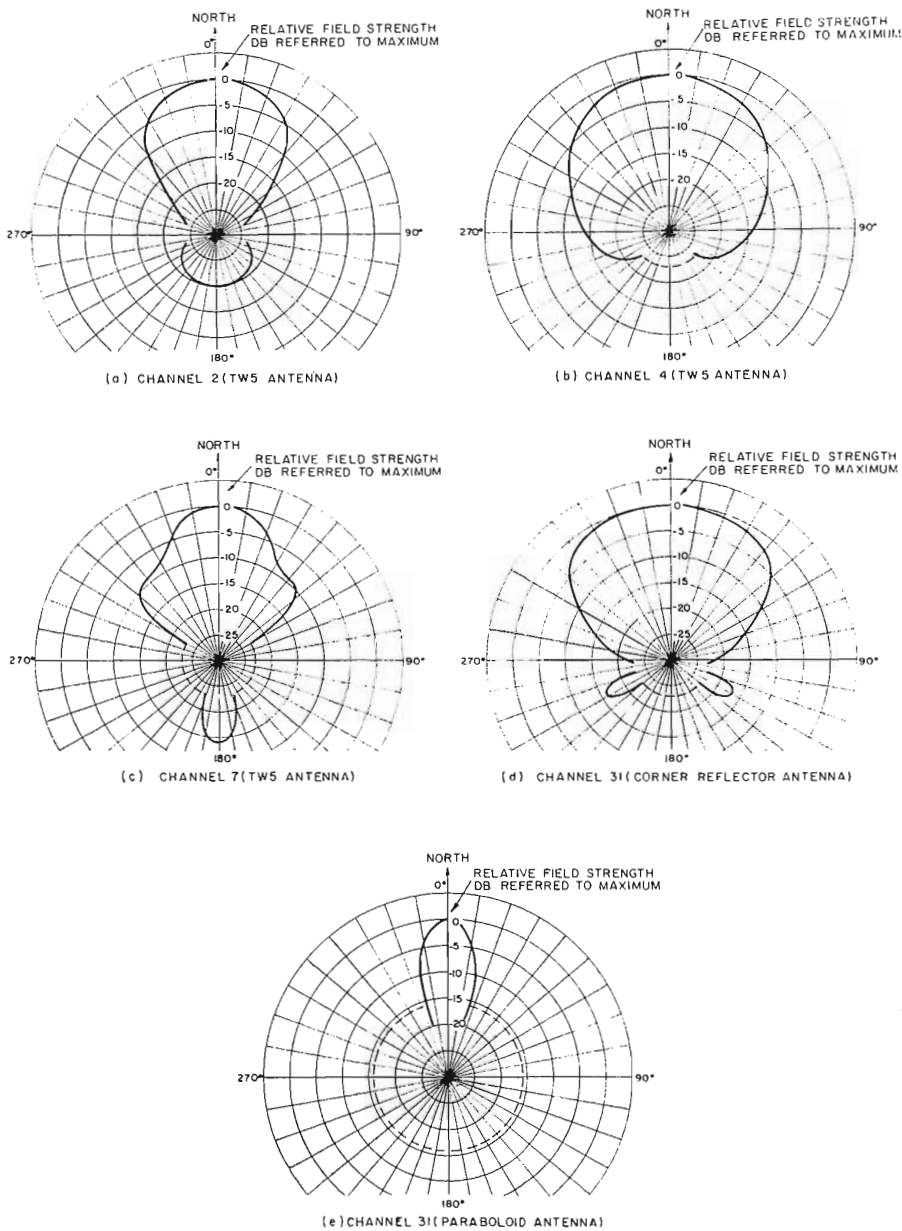

FIG. 7 RECEIVING ANTENNA AZIMUTH PATTERNS

TABLE II
Receiving Antenna Gains
db referred to $\lambda/2$ dipole for each
respective frequency

Antenna	Channel			
	2	4	7	31
TW-5	5	4	8	
Corner Reflector				7.7
Paraboloid				13

TABLE III
Picture Ratings
Based on multipath degradation

Rating	Description
1	Excellent; no multipath degradation
2	Fine; negligibly small degradation
3	Passable; moderate degradation
4	Marginal; objectional degradation
5	Inferior; lowest class of usable picture
6	Unusable

Indoor receiving antennas consisted of rabbit-ear dipoles for channels 2, 4 and 7 and the corner reflector and a dipole with reflector antenna for channel 31.

Manhattan Field Test

A VHF-UHF comparison of TV reception in highly built-up Manhattan is by its very nature a statistical problem. The topography of most of the island is a much less significant factor than the man-made features. The photograph of Fig. 1 shows part of the area and suggests by the wide variation of building heights and their random distribution that reception will be extremely varied.

Both indoor and roof-top reception are of interest. The only way to learn the statistics of reception under the exceedingly varied conditions of Manhattan is by measurement in a random selection of receiving locations in buildings and on rooftops. This could be on the basis of a rigorously random sampling process with the attendant practical problem that some of the apartment dwellers so chosen would not care to cooperate with the experiment. The method used instead was to choose the area of Manhattan where building heights are extremely varied and then deliberately choose available test locations with studied randomness.

The method of test location choice was recognized to lack mathematical rigor. It was clear that any existing significant frequency-dependent differences would be discovered by the field test. There could then remain a problem in determining the degree of significance of the differences since the sampling was not rigorously random. On the other hand, if no differences were uncovered, a more rigorous sampling process would likewise probably not reveal a difference. It fortunately turned out that frequency-dependent differences were so small that there was no need for going beyond the original sampling.

The multipath degradation was evaluated in terms of TASO subjective ratings.² The meanings of the ratings are shown in Table III.

The ratings were based on apparent picture quality tempered by knowledge of the received test waveforms. In all cases the waveforms included the two microsecond pulse and in most cases also included the multiburst test waveform for color comparisons on channels 4 and 31. The Manhattan ratings for the locations of Fig. 8 are shown in Table IV. The subjective evaluation data for Manhattan is based on a sampling of 239 locations. There were



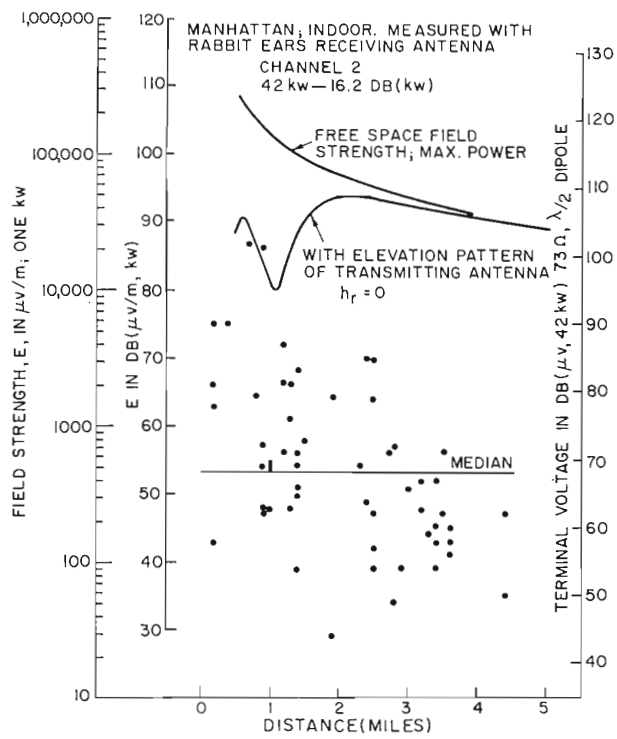

FIG. 9a

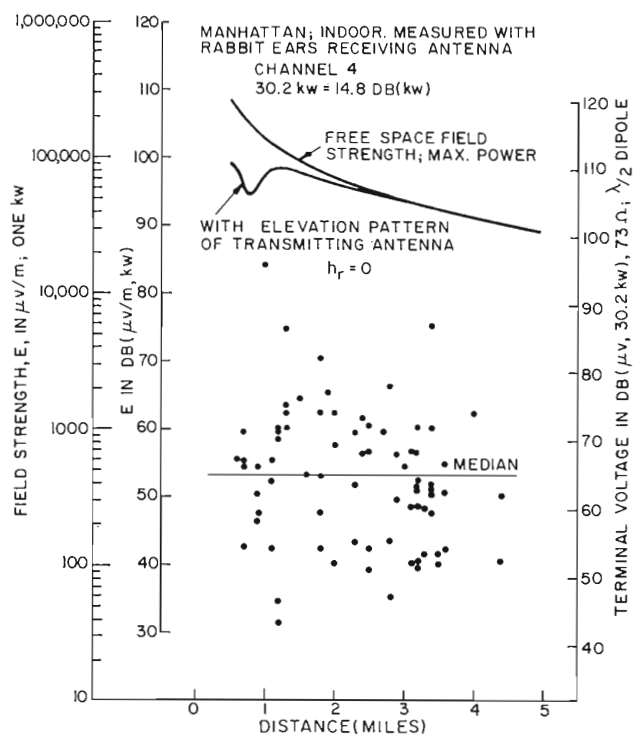

FIG. 9b

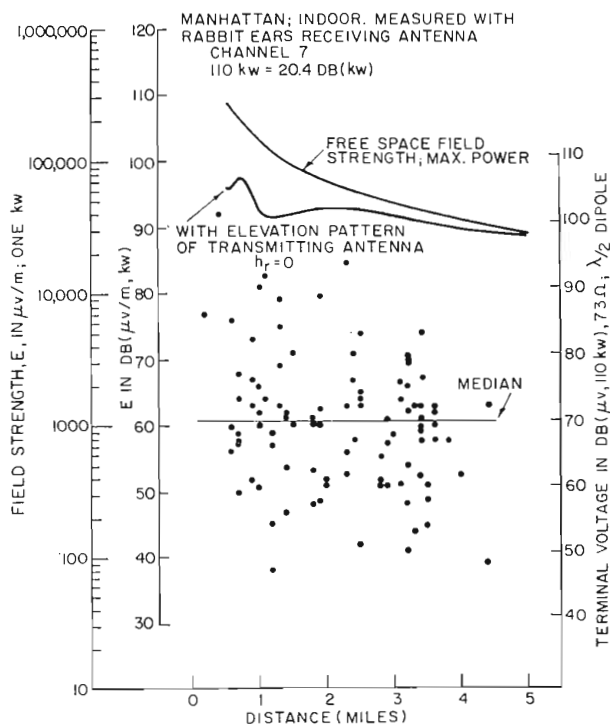

FIG. 9c

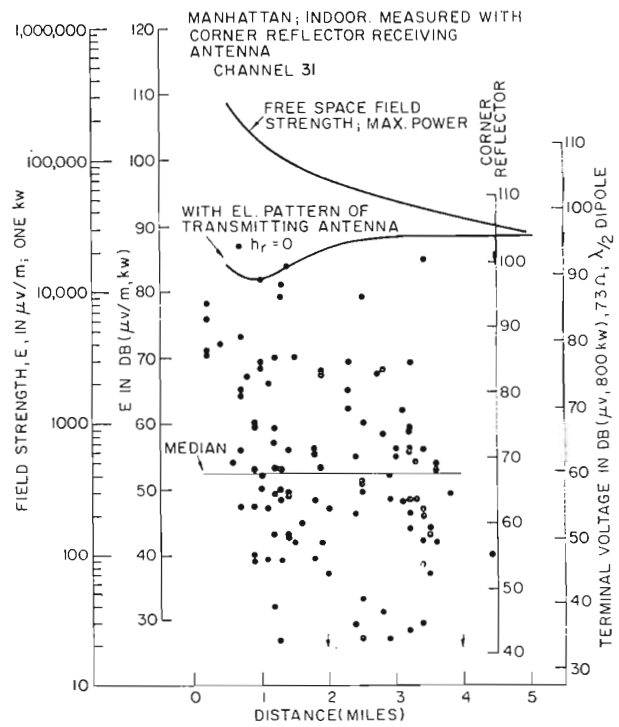

FIG. 9d

TABLE IV
Subjective Multipath Picture Ratings for Manhattan

Median Ratings

Receiver Type	Location	Low VHF	High VHF	UHF
Monochrome	Indoor	3.8	3.7	3.8
	Roof	2.7	2.4	2.7
Color	Indoor	4.3	4.4	4.4
	Roof	3.1	3.2	3.2

from two to four locations per building. The absence of frequency dependence is readily apparent. Roof reception about one grade better than indoor reception is quite consistent throughout the data. Color picture ratings are about half a grade poorer than monochrome ratings. A laboratory comparison⁷ of monochrome and color tele-

⁷ "A comparison of monochrome and color television with reference to susceptibility to various types of interference," G. Fredendall, RCA Review, September 1953, pp. 341-358.

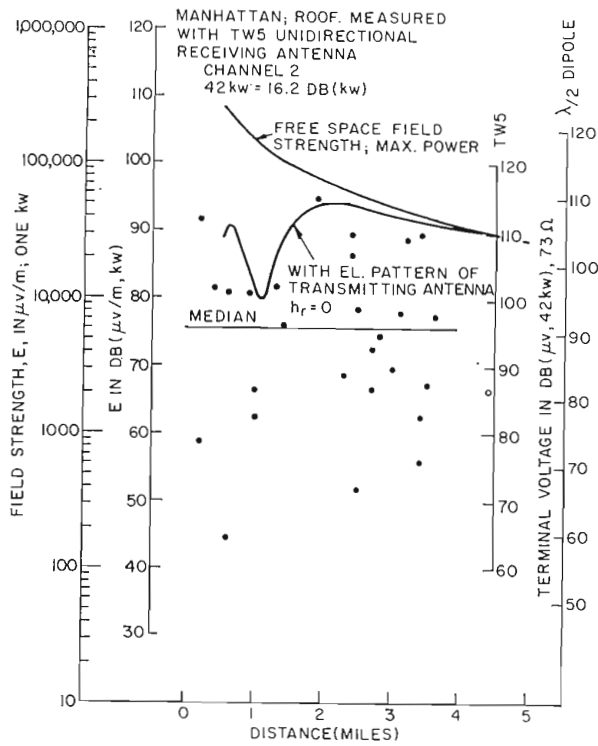

FIG. 9e

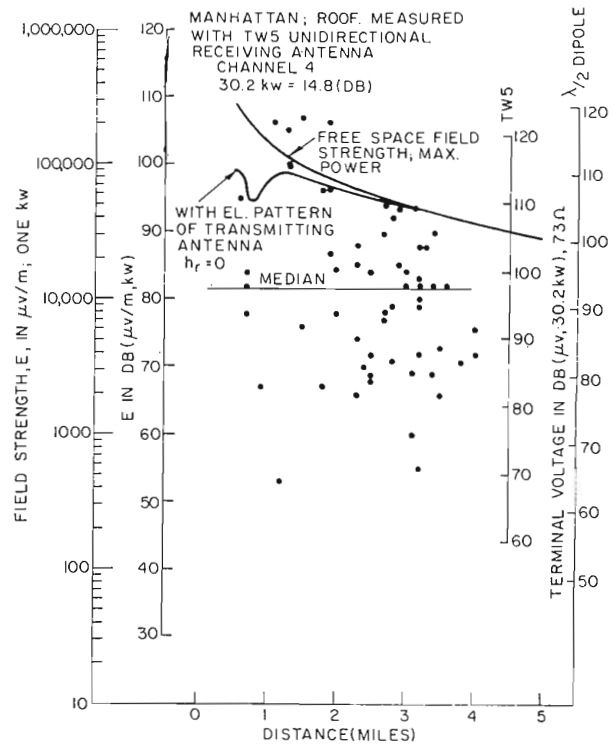

FIG. 9f

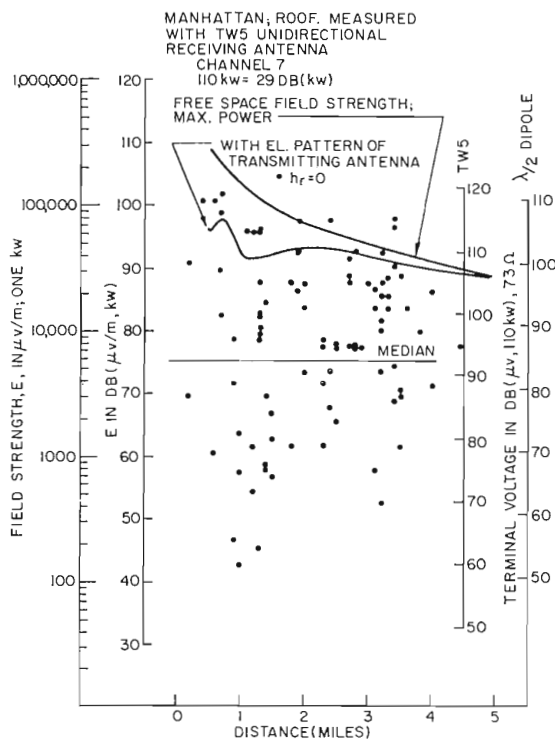

FIG. 9g

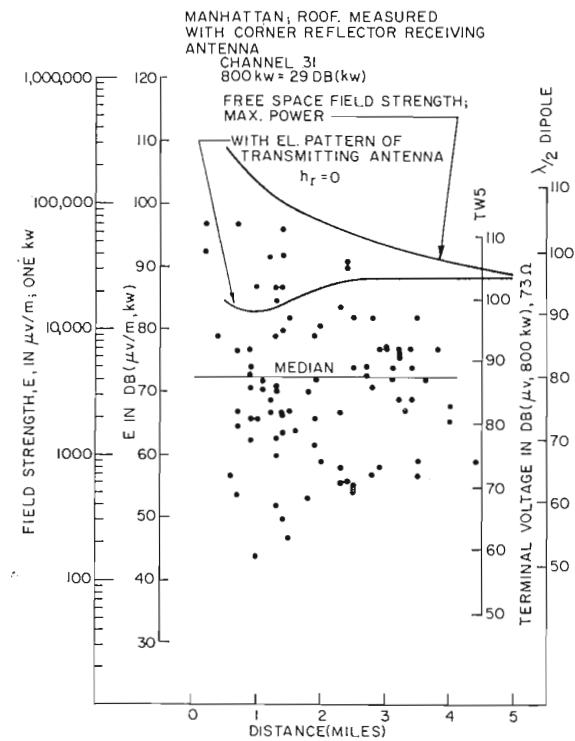

FIG. 9h

vision delayed image effects made in 1953 showed a similar tendency.

Reception is generally poor in most of Manhattan below 110th Street because of the varied building heights and the low angle of arrival. Far the most serious problem is the multipath degradation. There are installation problems which often fail to get deserved attention because customers are unwilling to stand the expense. If the

best quality possible is to be accomplished in an installation, there must be roof-top exploration which will not necessarily be fruitful. Since receivers high in tall buildings and within about two miles from the transmitter are exposed to unusually high field strengths, there are receiver and cable shielding inadequacies apparent in common installation practice. Even the best installation work is often undone by echoes resulting from new building construction.

Field strength and terminal voltage data for Manhattan are shown in Fig. 9 as a function of distance. It is noteworthy that on all frequencies the terminal voltage available from roof-tops was adequate to over-ride thermal and galactic noise as well as most man-made interference. UHF terminal voltages indoors were sometimes too low to over-ride noise. When this occurred VHF pictures usually suffered very severe multipath degradation.

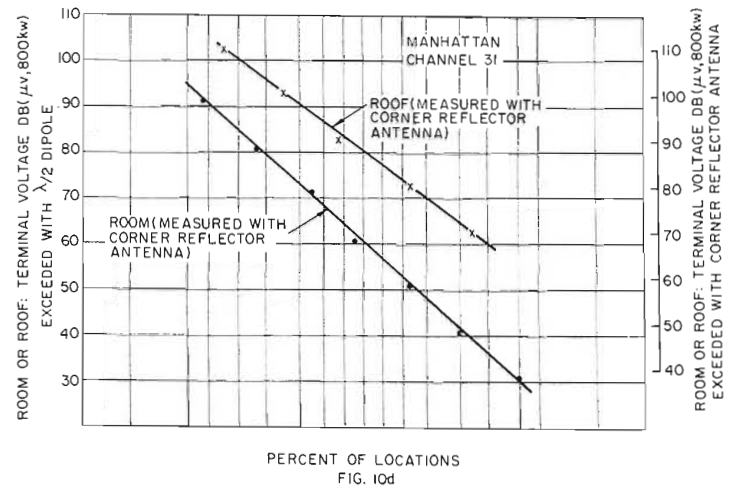
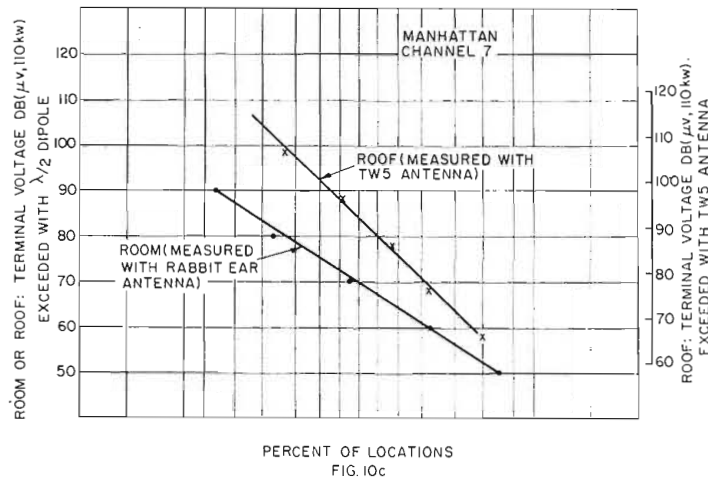
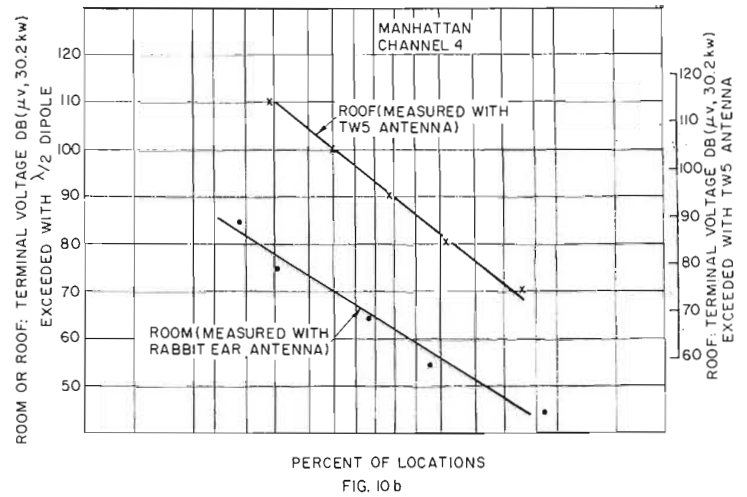
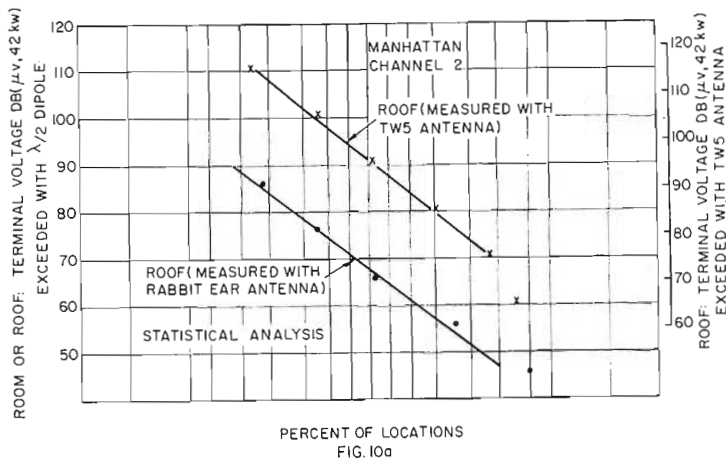

Receiver noise figures are shown in Table V. A satisfactory picture with respect to noise will be obtained with a signal-to-noise ratio of 30 db. For good commercial receivers the required terminal voltages are shown in Table VI.

A statistical analysis of the Manhattan data, made without regard for distance, is shown in Figure 10. The median terminal voltages are shown in Table VIII.

Miscellaneous Observations in Manhattan

Several potential problems were examined qualitatively during the field tests. Picture degradation from man-made interference was found to occur infrequently in Manhattan and Forest Hills. Evidently field strengths were high enough to over-

ride interference on all frequencies most of the time. There were occasional objectionable picture disturbances from moving about the room when indoor antennas were used. Little or no frequency dependence was noted in this effect. On rare occasions with indoor antennas there was objectionable distortion of sound from severe multipath propagation. This likewise was independent of frequency.

On Manhattan roof-tops (in the highly built-up smooth terrain below 110th Street) UHF improvement from use of the highly directional paraboloid antenna was usually demonstrable. However, orientation was so excessively critical, because of extreme field distortion, as to cast doubt upon recom-

mending general use of high gain receiving antennas. The broad-beam uni-directional antennas (UHF corner reflector and VHF TW5's) were quite satisfactory from an orientation standpoint. Use of antennas with poorer patterns than these can hardly be justified for Manhattan roofs.

The character of the picture degradation resulting from multipath propagation is apparent from the kinescope photos of Fig. 11. Almost all Manhattan pictures in the area sampled suffered from low resolution sometimes as low as the resolution of a 0.5 mc system. Discrete ghost images also were seen quite commonly with objectionable intensity. Typically the principal ghost images had time delays up to about two

TABLE V
Noise Figures of Good Commercial Receivers

Channel	Noise Figure, db
2	5
4	5
7	5
31	10

TABLE VI
Terminal voltages required
for 30 db signal-to-noise ratio (73 Ω)

Channel	Noise Figure, db	Terminal Voltage, db (μv)
2	5	35.7
4	5	35.7
7	5	35.7
31	10	40.7

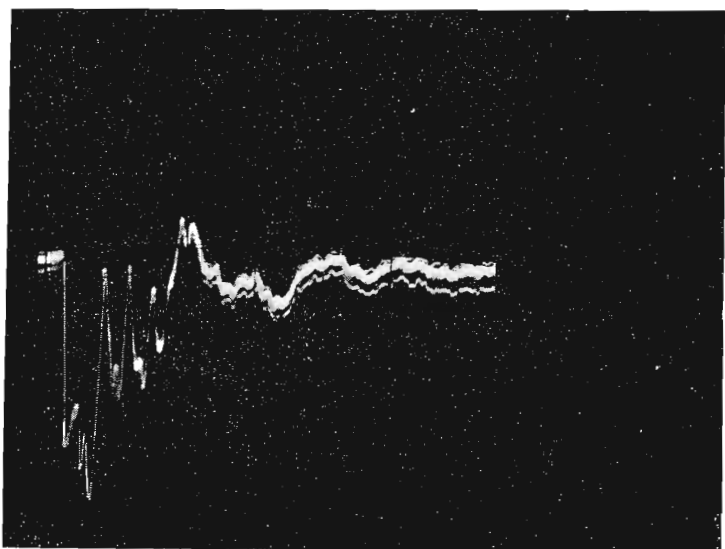
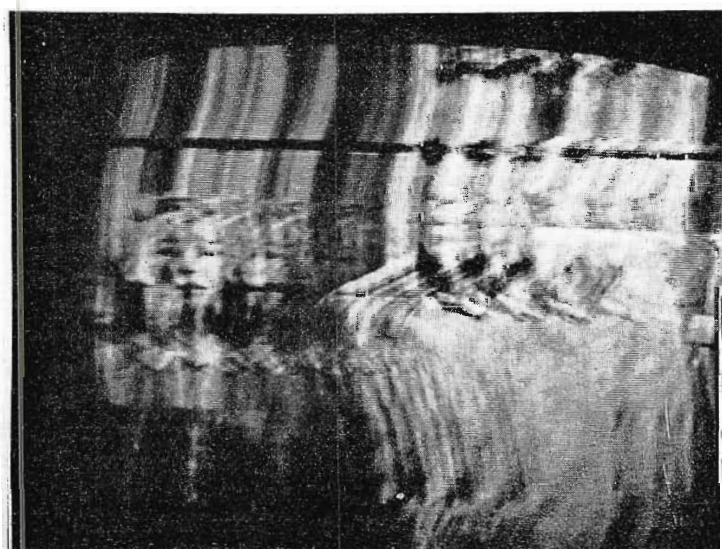
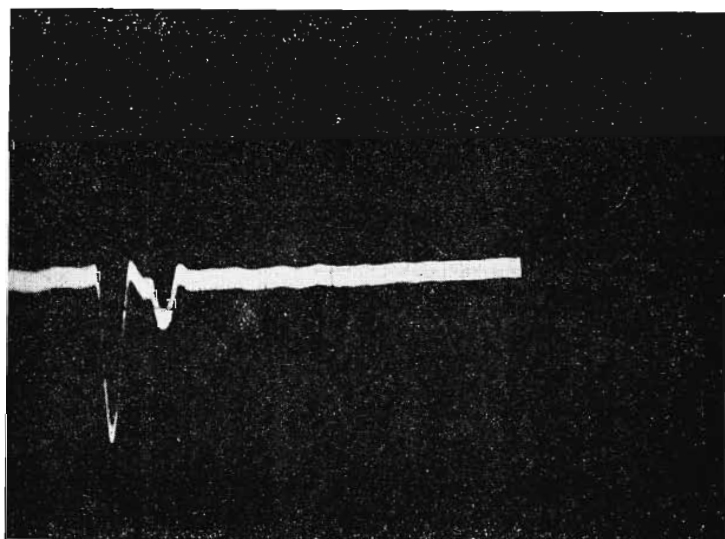
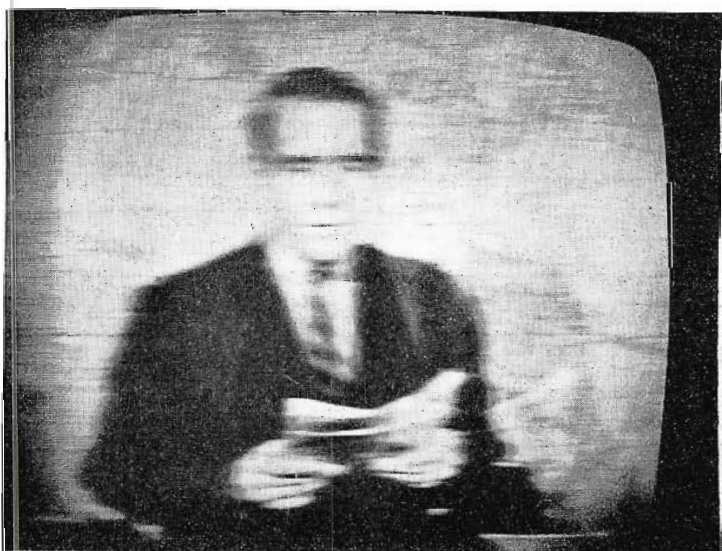
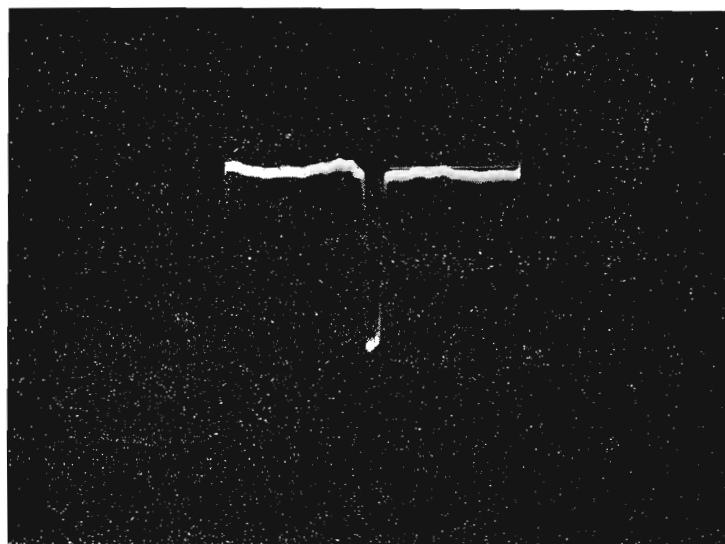

FIG. 11. Character of picture degradation resulting from multi-path propagation on Manhattan is indicated by these pictures photographed from the receiver kinescope. Test waveforms photographed simultaneously from the oscilloscope are shown in column at right.

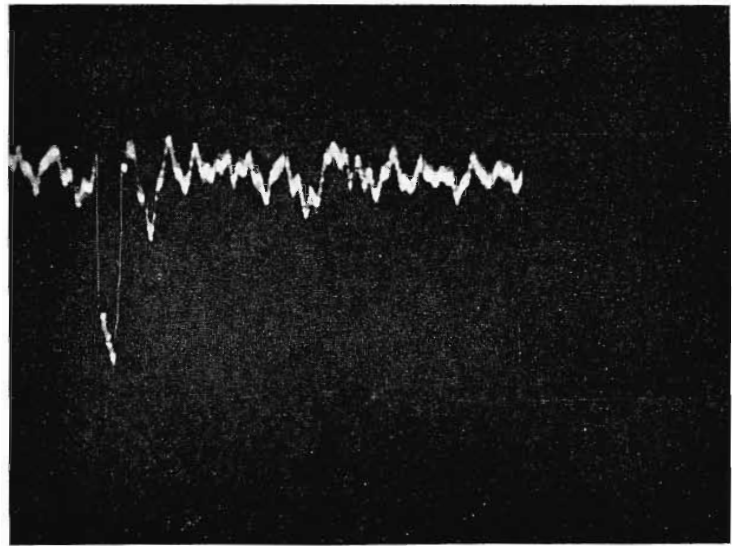

FIG. 12. Picture and test waveform resulting from long echo delay.

TABLE VII
Subjective multipath picture ratings (monochrome)

Location	Number of Samples	Median Ratings		
		Low VHF	High VHF	UHF
Forest Hills—Indoor	30	3.2	3.3	3.3
Forest Hills—Roof	15	2.7	2.6	2.5
Queens, 6-story apartment, Indoor	22	2.5	2.4	2.8
Queens, 6-story apartment, Street	12	2.6	2.5	2.7
2-story row houses, Street	7	2	2	2
2-story single houses, Street	6	2.5	2.5	2.5

microseconds although there were cases with substantial echo voltages with delays up to at least a full picture line or 63 microseconds as in Fig. 12. The accompanying test waveform data in Fig. 11 illustrates the supplementary value to the picture evaluator of the assistance gained from seeing the distortion of constant test signals which are common to all channels being compared.

New York City Outside Manhattan

The areas chosen for measuring multipath degradation from buildings included the entire range of building sizes and varieties to be found in the flat portions of the city, such as most of Queens and Brooklyn. The subjective ratings are given in Table VII. Multipath degradation was reduced in a consistent fashion as buildings became smaller until with two story buildings reception was rated "fine" on all frequencies. Since each of these sets of data represents a small range of distances, the terminal voltages can be given in terms of the statistical data shown in Table VIII.

Field Strength in Smooth Terrain Cities

An eastward radial line near the south shore of Long Island was chosen for a survey of field strength. Most of the radial passes through cities with one and two story single dwellings. The topographic profile, shown in Figure 13, has the measuring locations indicated. This radial comes about as close as any densely populated area can to fitting smooth, spherical earth propagation conditions. It will therefore be interesting to compare measured field strength with smooth spherical earth theory. Both measured data and theoretical curves are shown in Fig. 14.

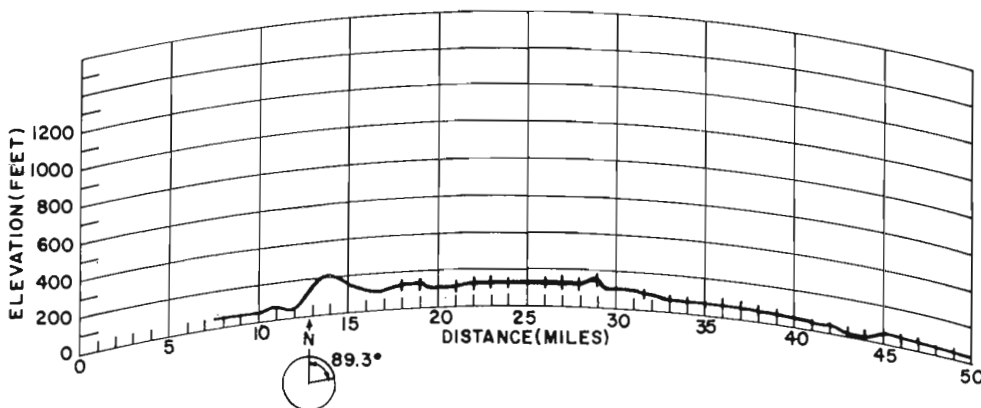

FIG. 13. ELEVATION PROFILE, EAST RADIAL (CURVATURE BASED ON 4/3 EARTH RADIUS)

EAST RADIAL. MEASURED WITH TW5 UNIDIRECTIONAL RECEIVING ANTENNA
CHANNEL 4
30.2 kw = 14.8 DB(kw)

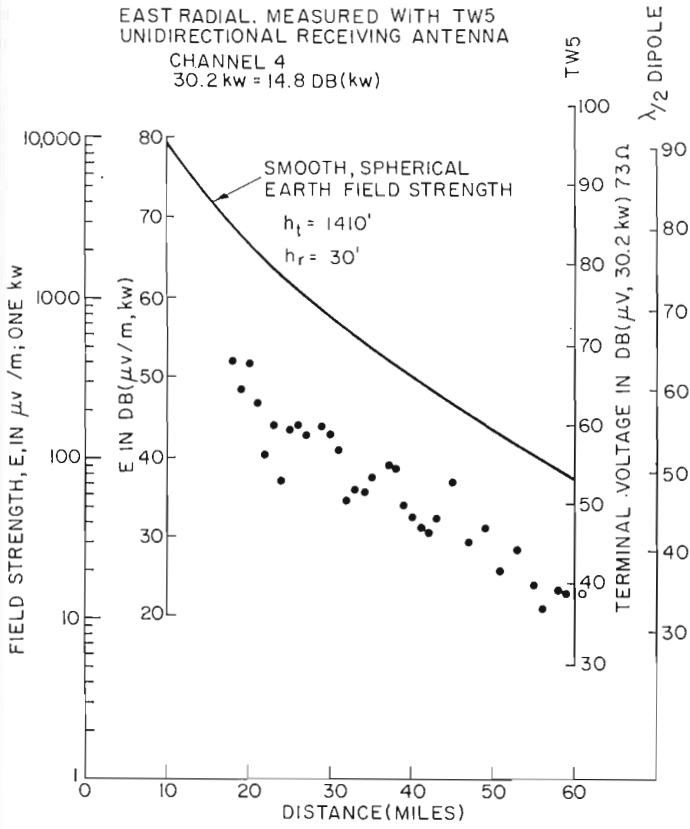

FIG. 14a

EAST RADIAL. MEASURED WITH TW5 UNIDIRECTIONAL RECEIVING ANTENNA
CHANNEL 2
42 kw = 16.2 DB(kw)

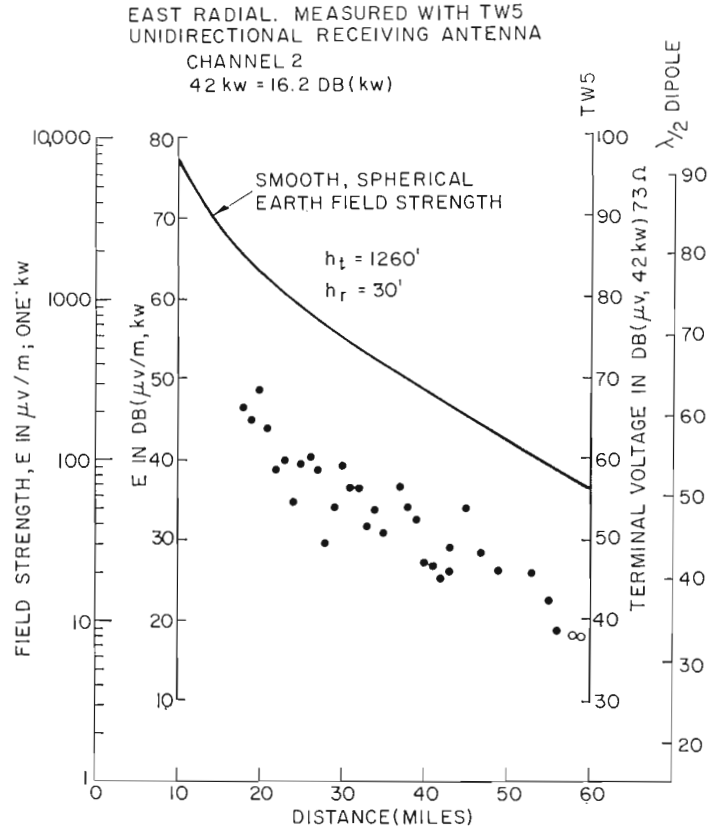

FIG. 14b

EAST RADIAL, MEASURED WITH TW5 UNIDIRECTIONAL RECEIVING ANTENNA
CHANNEL 7
110 kw = 20.4 DB(kw)

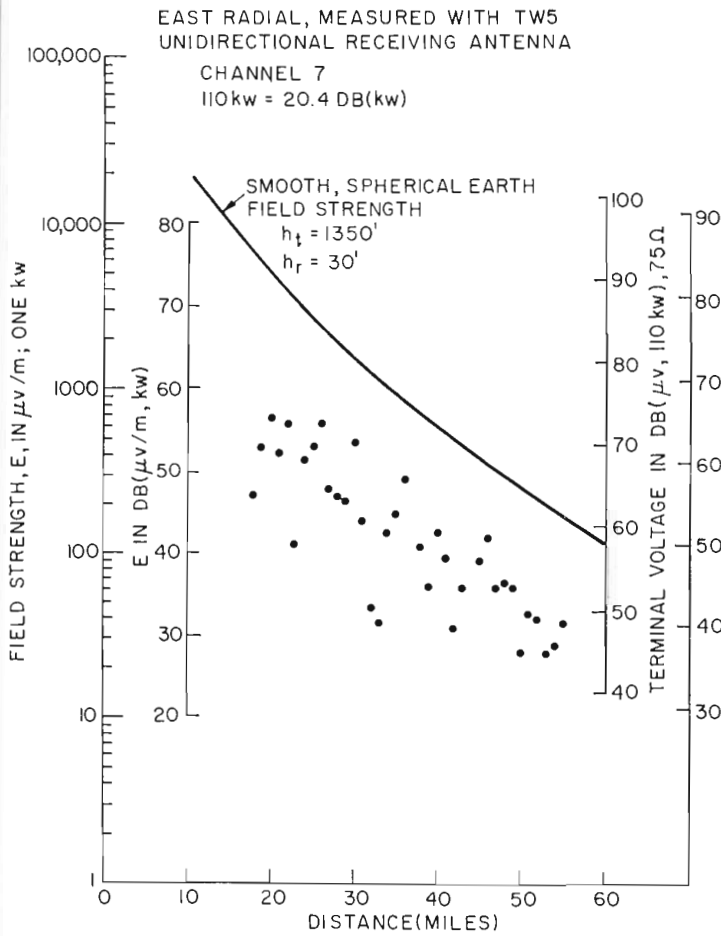

FIG. 14c

EAST RADIAL, MEASURED WITH CORNER REFLECTOR RECEIVING
CHANNEL 31
800 kw = 29 DB(kw)

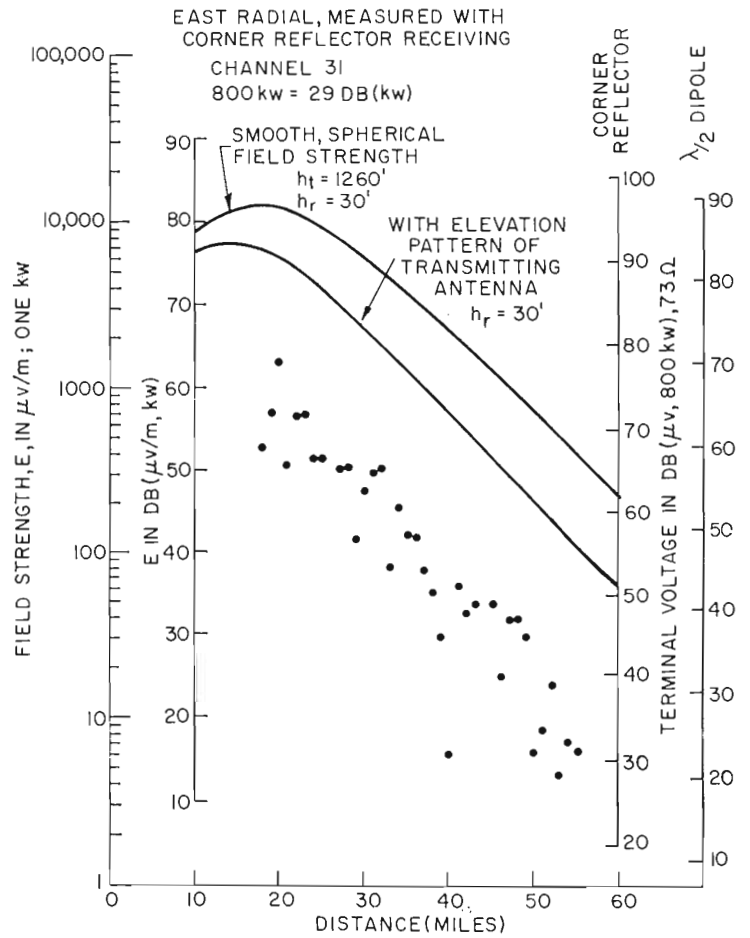

FIG. 14d

It is apparent that the theory bears a useful relationship to the measured data since the theoretical curve and the average of field strength data have the same slope for each respective frequency. There is an average departure in measured field strength below the theoretical curves which probably can be ascribed to clutter loss, the average reduction of apparent field strength resulting from local shadowing and field distortion. This kind of loss is always in evidence around buildings and trees as a consequence of multiple reflections and shadowing.

Picture degradation from multipath effects was known from the data of Table VII to be negligible under the conditions of this radial survey. Therefore only field strength was measured; picture observation was deemed unnecessary. The unidirectional VHF antenna and the corner reflector UHF antenna were used at heights above roof-tops about the same as prevailed on roof-tops in the respective areas. Usually this meant a height above the street of about 30 feet.

Reception in Rough Terrain

A westward radial line through North Jersey was chosen for observing rough terrain effects. Local clutter was avoided so that topographic effects would predominate. The topographic profile is shown in Fig. 15, again with measuring locations indicated. Field strength was measured at 30 feet with the unidirectional VHF antenna and the paraboloid UHF antenna. Pictures were observed wherever possible. The measured field strengths are shown in Fig. 16.

From 14 miles and beyond, the UHF field strength was usually too low for direct

Channel	Terminal Voltage Median db (μv)				
	Antenna	Roof	Antenna	Indoor	Ave. Distance (mi.)
Manhattan					
2	TW5	96	R.E.	68	2.5
4	TW5	97.5	R.E.	65	
7	TW5	92	R.E.	70	
31	C.R.	87.5	C.R.	67.5	
Forest Hills					
4	TW5	80	R.E.	56	7.3
7	TW5	81	R.E.	59	
31	C.R.	81	C.R.	60	
Queens (6 story)					
4	No roof data		R.E.	56	5.2
7			R.E.	65	
31			C.R.	69	

picture observations. The direct and the mountain-reflected signals were measured with the paraboloid antenna by use of the equalizing pulse. The time separation between direct and reflected pulses thus afforded made it possible to separate the direct and reflected signals for measurement. In the shadowed valley at 15 miles between the two Watchung ranges, the UHF reflected signal was comparable in magnitude to the direct signal. This means that there would be multipath degradation if the signal level were high enough for picture observation unless better receiving antennas become available.

Similar pulse measurements for channels 2 and 7 corroborated the conclusions from direct picture observation, which was possible on these channels. There was very little multipath degradation expected on the basis of the pulse measurements and in fact very little was seen in the VHF pictures.

Because of the transmitting antenna azimuth pattern uncertainty of +4 to -8 db for channel 31 and the rapid variation of elevation pattern with angle, no attempt was made to extract shadow losses from the measured data. This seriously limited the usefulness of the UHF field strength data obtainable in rough terrain.

The UHF elevation pattern problem alluded to under Transmitting and Receiving Antennas is illustrated in Fig. 17. In the vicinity of 0° elevation angle the channel 31 relative field is seen to be substantially lower than the channel 2 relative field as a result of elevation pattern differences. Over smooth terrain with constant elevation this difference is relatively unobjectionable. If there are hills or a gradual rise away from the transmitting antenna of the same order of magnitude as the transmitting antenna height, the pattern difference has serious consequences which are illustrated in Fig. 18. The antenna elevation patterns are superimposed on spherical earth coordinate paper. Because the elevation scale is greatly stretched relative to the distance scale, the angle scale is distorted. However, propagation rays appear as straight lines. In the example shown, a

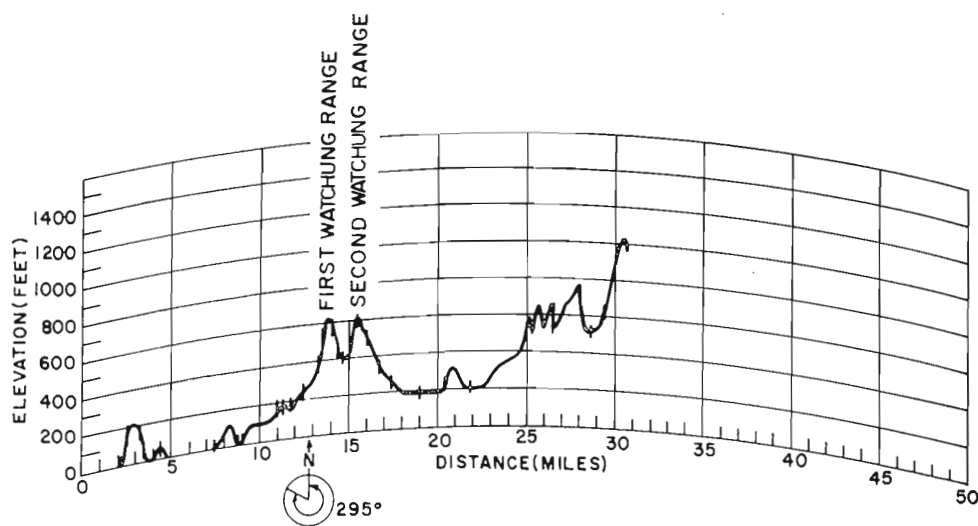

FIG. 15. ELEVATION PROFILE, WEST RADIAL (CURVATURE BASED ON 4/3 EARTH RADIUS)

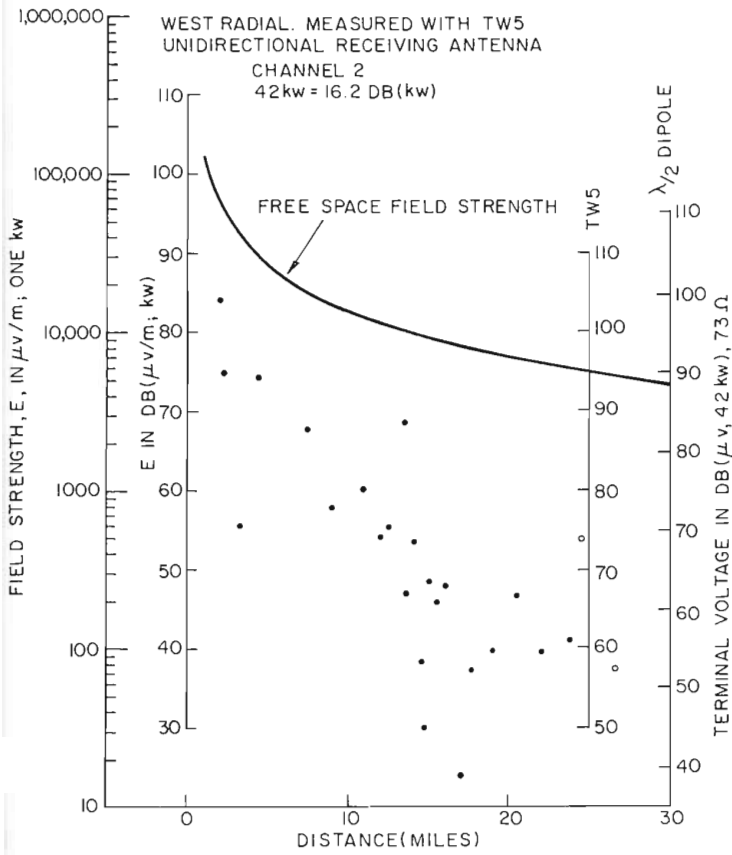

FIG. 16a

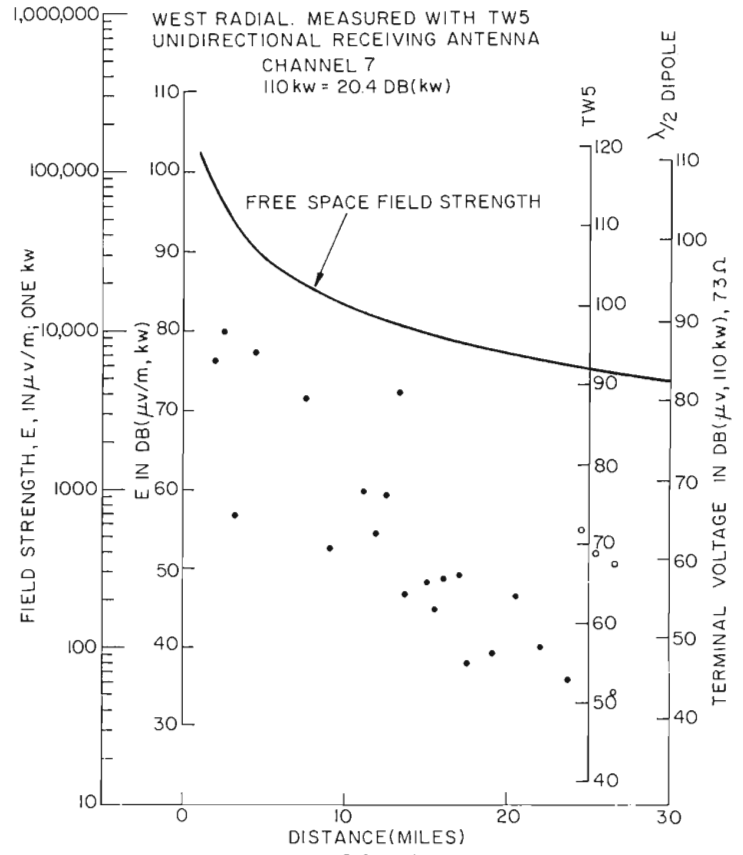

FIG. 16b

500-foot hillcrest at 17 miles receives maximum radiated power from the broad channel 2 elevation pattern. The narrower channel 31 pattern is down 10 db at the same crest. In addition, the channel 31 transmission will suffer greater diffraction loss than lower frequency channel 2 transmission.

UHF Receiving Antenna Effective Gain

High receiving antenna gain is not only possible with physically realizable antenna sizes, it is particularly desirable for UHF TV. The receiver terminal voltage, for a given field strength, is inversely proportional to frequency when $\lambda/2$ dipoles are used. Since a UHF $\lambda/2$ dipole is physically much smaller than a low VHF $\lambda/2$ dipole, it is reasonable to use an array of dipoles (or the equivalent) for UHF reception. The fact that large aperture antennas depend upon a uniform field distribution for gain leads to the suspicion that their effectiveness will be reduced in cluttered surroundings.

An experiment was performed in Long Island cities to compare the effective gain of a corner reflector (5 sq. ft. aperture) and a paraboloid (31 sq. ft. aperture). As a practical matter, installation technicians cannot be expected to explore in height above roof-tops. Therefore a fixed height, 10 ft., above average roof level was used

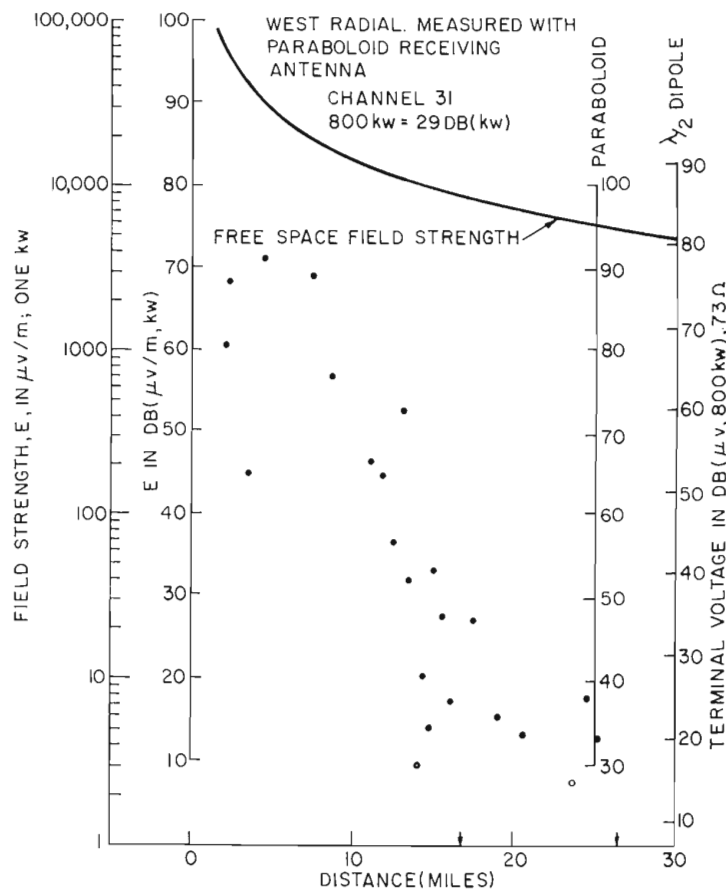

FIG. 16c

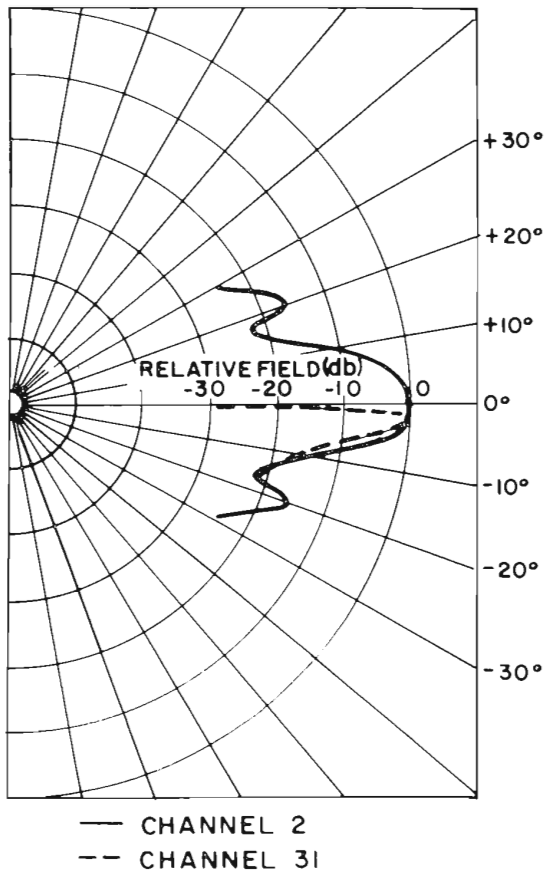

FIG. 17. TRANSMITTING ANTENNA ELEVATION PATTERNS

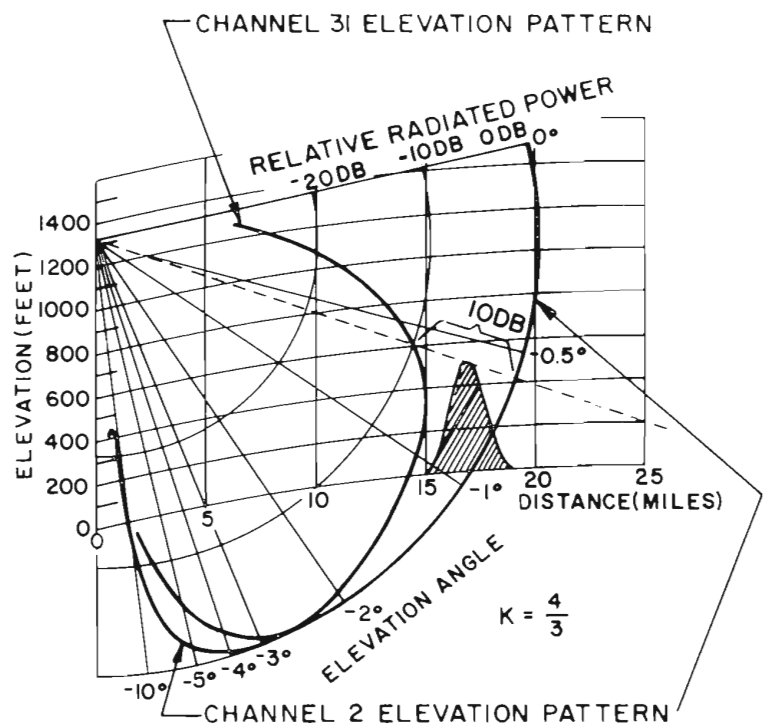

FIG. 18. ELEVATION PATTERNS SUPERIMPOSED ON SPHERICAL EARTH COORDINATES

for the comparison. The measurements were made in the street where fields are probably no less uniform than above roof-tops.

The measured free space gain of the paraboloid and the corner reflector antennas are respectively 13 db and 7.7 db referred to a $\lambda/2$ dipole. Thus in a uniform field the paraboloid gain is 5.3 db higher than the corner reflector gain. The measured median gain of paraboloid over corner reflector antenna in cluttered surroundings was 2.3 db. This means that high gain UHF receiving antennas may in fact be expected to have reduced effectiveness in cluttered surroundings.

Conclusions

In Manhattan below 110th Street, a smooth-terrain extremely built-up area, there was no frequency dependence apparent in the subjective picture ratings based on multipath degradation. Roof-top reception was of poor quality and the multipath degradation was highly unpredictable for specific locations even in most line-of-sight locations. Indoor reception was very poor as a result of high direct-path attenuation and the consequent multipath degradation. Color pictures in Manhattan below

110th Street were rated even poorer on the basis of multipath degradation than monochrome pictures.

In a six-story apartment area in smooth terrain the multipath degradation was only moderate even with indoor antennas. In two-story-dwelling areas the degradation was very slight. Again there was no frequency dependence.

The median terminal voltage with outdoor receiving antenna was adequate on all frequencies in the multipath-troubled part of Manhattan. In smooth terrain the useful residential area distance ranges were about 55 miles on channel 2, 60 miles on channel 4, over 60 miles on channel 7, and 48 miles on channel 31. This was based on actual average radiated powers on the elevation pattern maxima of 42, 30.2, 110, and 800 kw for channels 2, 4, 7, and 31 respectively. The present state-of-the-art noise figures from Table V were assumed. These are 5, 5, 5, and 10 db for the respective channels.

The west radial illustrates the rough terrain problems of UHF TV. With loss both from shadowing and from the narrowness of the transmitting-antenna elevation pat-

tern, the field strengths were far below useful level at all distances beyond 14 miles except on line-of-sight-crests. Approximately double this distance range was satisfactorily served with the VHF systems. There was evidence in hilly terrain of multipath degradation more severe on the UHF channel 31 than on the lower frequency channels.

The high-gain receiving antennas which are needed for UHF use in rough terrain or for extending the fringe area range in smooth terrain fail to realize their free space gain by a substantial margin. In areas with building heights as variable as Manhattan below 110th Street, high gain UHF receiving antennas are moderately effective in reducing multipath degradation but they are excessively critical to orient.

Credits

A group of RCA Service Company engineers performed the field measurements. Special test signals were furnished by CBS, NBC, ABC, and WPIX. The fullest cooperation was enjoyed from the operating staff of the channel 31 station, WUHF, the Federal Communications Commission engineering staff, and the several RCA Service Company branches in New York City.

MEGAWATT UHF TEST STATION

This article describes a high power TV facility commissioned early in 1961 by the FCC for use in its tests of UHF signal coverage. Design details of the RCA 50 KW transmitter are presented in a companion article which begins on Page 68. Following completion of the tests in October, 1962, WNYC (Municipal Broadcasting System) licensee for New York City's Channel 31 arranged to acquire complete facilities of WUHF for use in non-commercial broadcast operation (see page 26).

October 31, 1962 marked the completion of the FCC UHF experimental tests over Station WUHF, Channel 31, which was installed on the 80th floor of the Empire State Building, New York City.

Both color and monochrome telecasts were made in the FCC sponsored tests to at least 100 standard color and black-and-white receivers installed in Manhattan and adjoining boroughs. The purpose of the project was to obtain engineering data on UHF signal coverage of a large metropolitan area.

WUHF Facilities

An RCA TTU-50A UHF high powered 50 kw transmitter was installed as the power source for WUHF and was provided by RCA with a unique arrangement of other equipment to provide a complete self-identifying station. This equipment was leased and installed by RCA under a contract awarded by the FCC February 24, 1961. In a separate agreement with Municipal Broadcasting System, RCA equipped WNYC—the New York City owned station which operated WUHF—with an array of TV studio equipment for use in programming. This included four TK-60 Cameras, a TRT-1B TV Tape Recorder, TK-21 TV Film Camera, two TP-16 Film Projectors and a TP-11 Multiplexer. TV cameras, tape recorder and the 16 mm film chain were located in WNYC's downtown studios. The transmitter and a TV Slide Projector chain were installed on the 80th floor of Empire State Building.

The installation was accomplished through the services of RCA's prime subcontractor, Belmont Electric Company, under the supervision of RCA representatives.

Empire State Building's Eighth TV Outlet

There were several complexities to the design of a high power TV station for Empire State Building, and installation posed some problems, too.

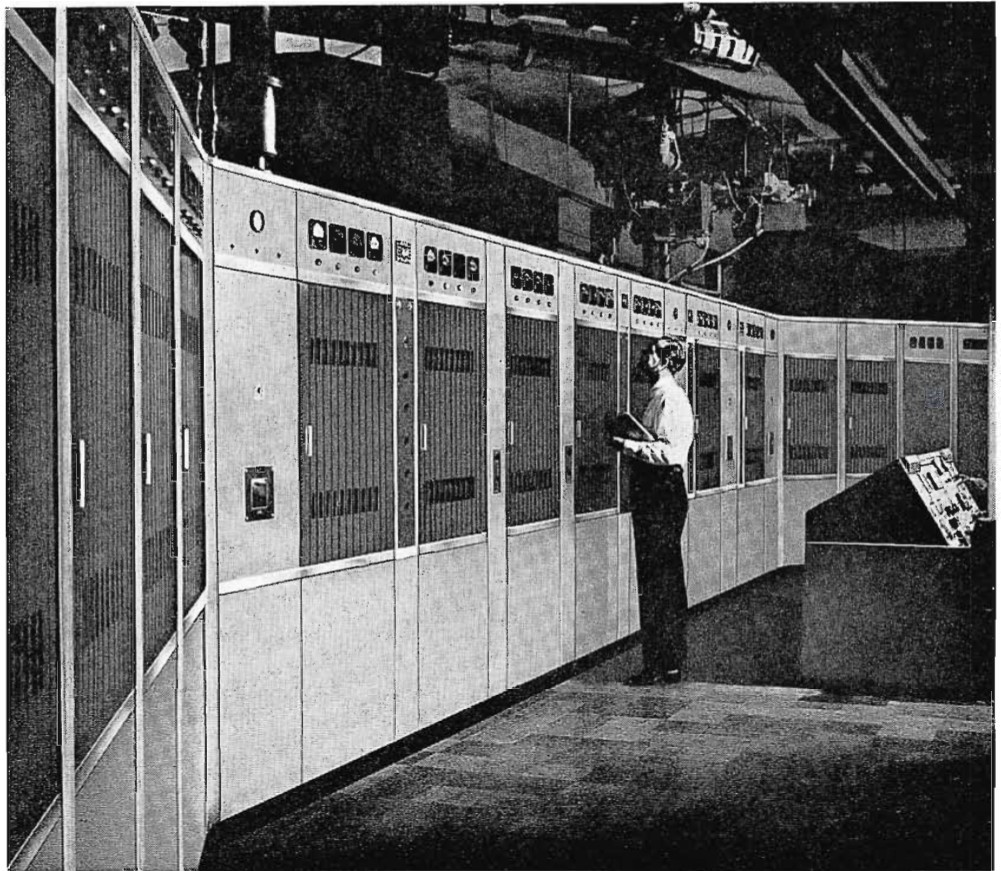

FIG. 1. Installation of RCA Type TTU-50A 50-KW UHF Television Transmitter on 80th floor of Empire State building for FCC tests.

Already housed by the 35-year old skyscraper were seven other TV stations and several FM outlets all drawing power from an underground line originating at Con Edison Electric. A prime requisite of any new transmitter, therefore, was minimum power consumption. The 80th floor site selected for the transmitter was 400 feet below the antenna, a feed line distance which, together with the high r-f power to be transmitted, called for low-loss, $9\frac{3}{16}$ inch coaxial line. Equipment was to be moved by inside elevators to the 80th floor, only after normal working hours. Weight was an everpresent factor; floor loading requirements were to be met of course, and installation and test of equipment had to be made with no power interruption to other broadcast services.

Four major phases to the installation encompassed building modifications, equipment installation, wiring, and proof of performance tests. Successful overlapping of these functions saved time, and the work was completed within six months from April to October 1, 1961, when test transmissions began.

Transmitter Area Remodeling

The transmitter room area was formerly offices with windows along the north walls of the building. Extensive renovation and construction work was necessary in the area before any equipment could be moved in.

To avoid cutting into the concrete floor of the building, a new tile-covered floor was constructed six inches above the existing floor to support the TV equipment and at the same time house the ducts for water lines and wiring. The new floor included removable covers for access to the ducts beneath, and a ramp that permitted equipment to be moved in on rollers and trucks and eliminated any obstruction such as a step at the entrance to the transmitter area.

Part of an existing office wall was retained in the construction of a pump room. A metal double door was installed to allow sufficient room to move in heat exchangers, water tanks and pumps. Louvres and air ducts for the heat exchangers were installed in the two windows with electric strip heaters to automatically control the temperature of air intake to the exchangers.

Ventilation of the transmitter area was a major problem encountered during building modification. In most cases windows had to be removed completely and custom designed louvres and frames fitted into the openings. Ducts were provided with "man-hole" type openings and covers so that louvres could be serviced from the inside of the building. Louvres were of special design in other respects, too, because due to thermal drafts around the outside of the building at the 80th floor level the direction of movement of rain and snow is unpredictable.

Six special air-cooled plate transformers were obtained by RCA to replace the oil-filled types normally used in high power transmitter installations. Use of these transformers eliminated the need for the usual explosion-proof transformer vault, oil drain pump and tank which, in the case of Empire State Building would have imposed serious problems. The air-cooled types required only a fireproof, ventilated vault. This was constructed of concrete block at the northeast corner of the transmitter room.

FIG. 3. Cross sectional diagram of upper floors of Empire State building showing path of coaxial transmission line.

Transmission Line Installation

A major project in the construction of WUHF was the installation of the 430 feet of pressurized $9\frac{3}{16}$ -inch-diameter copper feed line interconnecting the transmitter filterplexer and the antenna. The complete run utilizes some 40 straight sections and elbows with a total weight of over 7000 pounds.

The longest piece of $9\frac{3}{16}$ inch transmission line that could be handled in the building was 10 feet. The optimum length of transmission line was 9 feet 9 inches, when junction discontinuities were taken into consideration for Channel 31. Thus 9 feet 9 inch lengths were fabricated for this installation.

After inspection of the site and conferences between Empire State Building architects and RCA engineers a layout of the transmission line run was decided upon. It was to follow a vertical path adjacent to the elevator shaft from the 81st floor

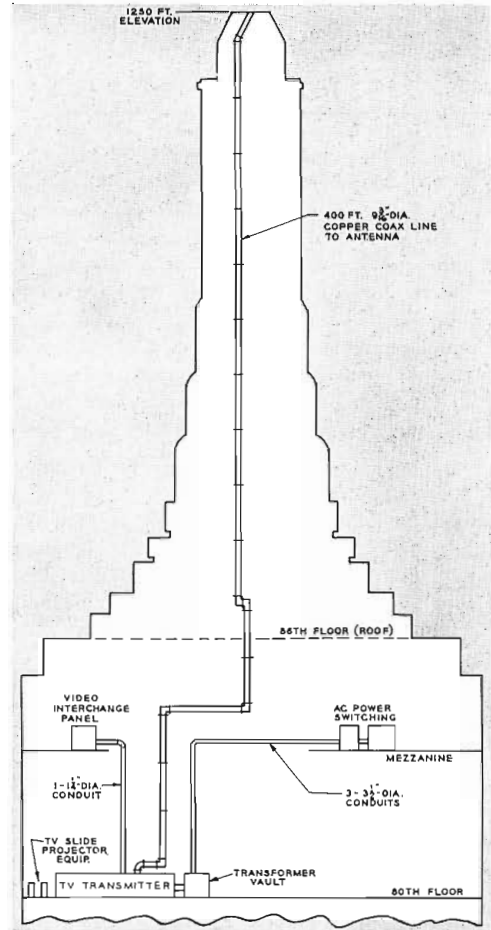
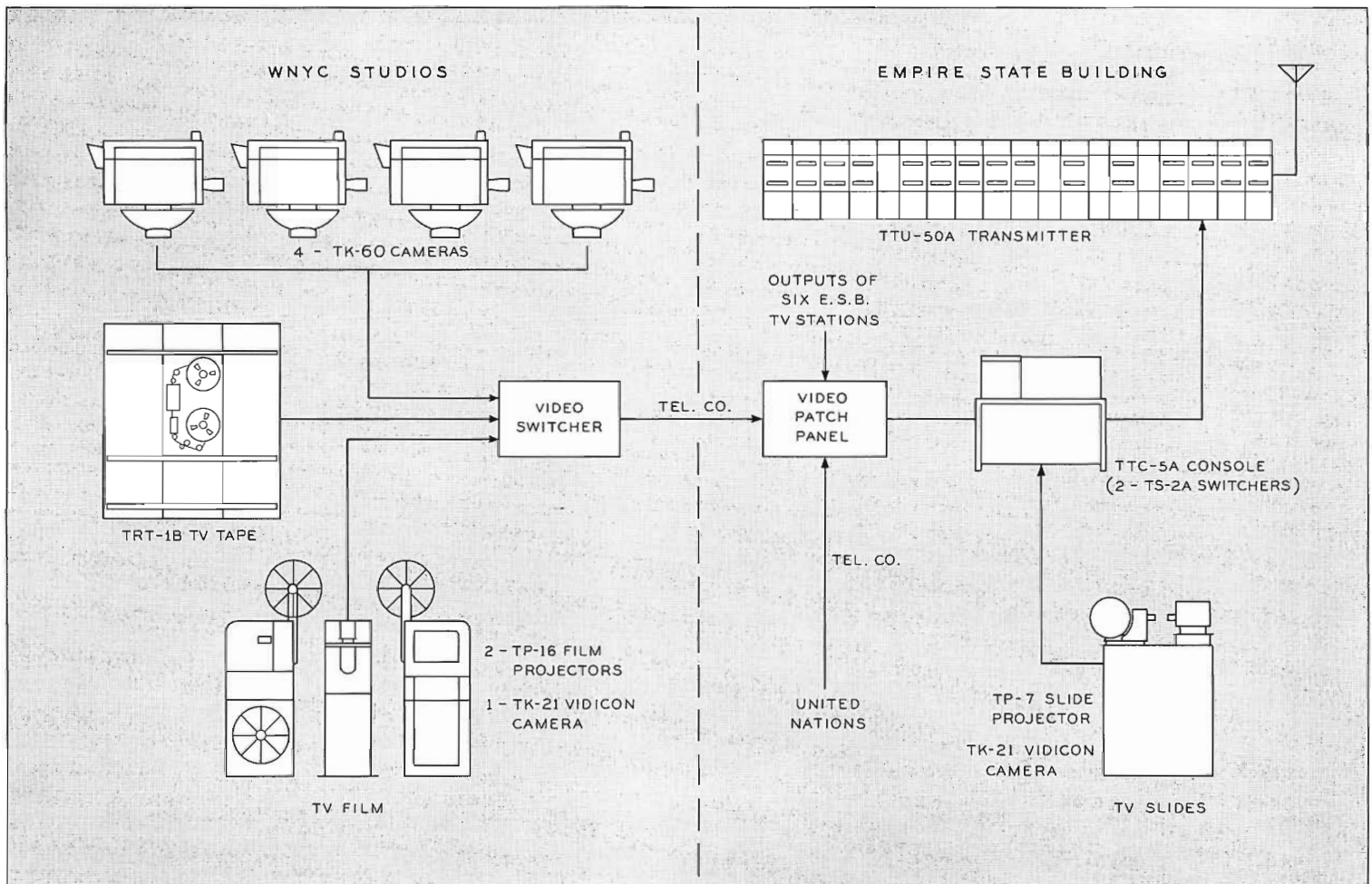

FIG. 2. Schematic block diagram of WNYC and WUHF video interconnections.



through the 84th floor. Then, in the ceiling of the 84th floor the line was to make a right angle bend, running parallel to the ceiling through a series of elbows, and passing through an unused air vent, finally to reach a vertical run position on the opposite side of the room. From here the line was to travel to the 88th floor, make a short cross-over and enter a vertical pipe shaft which runs to the top of the building tower.

Actual procedure was to install the vertical sections of the line first, i.e., from the 80th floor to the 88th floor, and then from the top of the tower (approximately the 105th floor) down to the 88th floor. This facilitated the measurement and correct positioning of the required crossover sections to mate the vertical runs. All transmission line sections were fabricated at the supplier's plant to specified lengths and shipped ready for installation. For the crossover portions, measurements for special lengths were obtained by temporary use of the outer shell only (inner conductor removed) to reduce the weight of the assembly and thus facilitate handling.

Horizontal sections are suspended by horizontal spring hangers and in this manner receive the torque exerted by the normal expansion and contraction of the vertical sections of line. In some cases special bolted flanges were required to prevent rotation of the line and thus assure vertical transmission of torque.

It was necessary to cut the steel structure for emergence of the line from the top of the tower, and to reinforce the remaining structure and provide a water-tight seal around the line.

Portions of the marble walls on the 81st, 82nd and 83rd floors were removed for installation of the line. Marble was then re-installed on a plastered structure enclosing the line. Similar enclosures were constructed, plastered and then painted on other floors where the transmission line would otherwise be exposed. Most of the line installation in the tower was accomplished during normal working hours.

A-C Power Cabling

The source of a-c power in Empire State Building is a 140,000-ampere switch vault located on the 84th floor mezzanine.

Elevators and existing TV stations in the building receive power from this vault through two separate (East and West) banks of breakers which are energized by two 208-volt, 3-phase feeder branches.

WUHF's source of power was to be a 2000-ampere breaker (which matched the others except that it had 1000-ampere limiting fuses) connected to the West bank feeder. Rather than risk interruption of power during installation, it was decided to temporarily transfer the West bank load over to the East bank breakers, and then deenergize the West bank for installation and interconnection of the WUHF breaker. To accomplish this, jumpers were installed between breakers and the temporary power source to assure continuous service while the changeover was being made. After installation and interconnection of the WUHF breaker and transmitter room feedlines, jumpers were removed and original connections for the West bank loads were restored.

Power feed lines to the WUHF transmitter room consist of nine 500,000 circular mil cables, three for each leg of the 3-phase, 208-volt circuit, plus a 60 KW line for automatic antenna de-icing equipment. All lines are installed in three 3½-inch aluminum conduits. The 3-phase power enters a second (1200-ampere)

breaker in the transmitter room which feeds a 208/460-volt step-up transformer to meet the requirements of the TTU-50A Transmitter.

Video Interchange Connections

The picture "nerve center" of TV operations in Empire State Building is a Video Interchange Panel which was installed in 1951. Terminated in this patch panel are the program circuits of TV stations throughout the building, providing almost unlimited possibilities for interconnection of stations in emergencies or for other purposes.

Video interconnections between this panel on the 84th floor and WUHF patch panel facilities on the 80th floor were made by means of RG-11/U coaxial cables installed in 1¼-inch conduit. Also installed in the conduit was a 26-pair audio and intercom cable interconnecting WUHF with other TV stations in the building.

Transmitter Room Installation

Equipment for the pump room such as heat exchangers, water tanks and pumps

FIG. 4. Video patch facilities of Empire State building and WUHF.

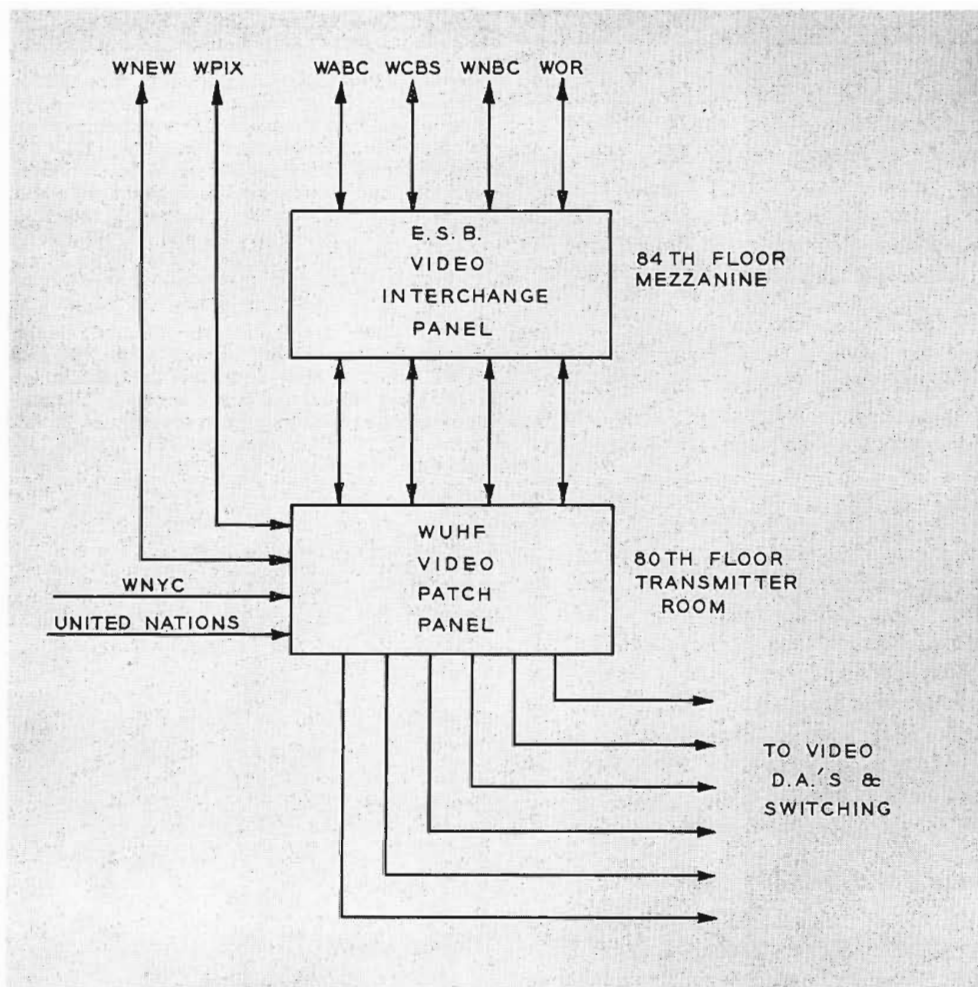

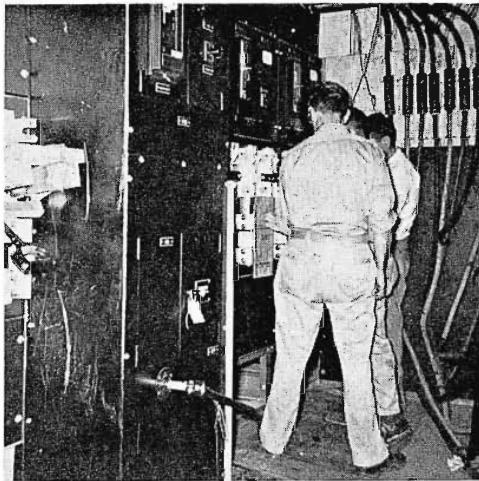
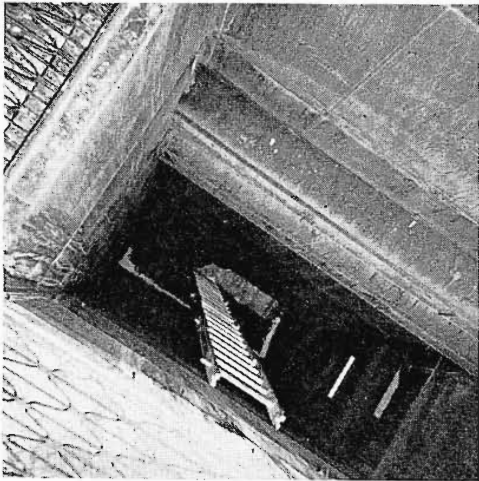

FIG. 5. (Upper Left) Vent shaft from 84th to 88th floors, used for transmission line. (Upper right) completing power changeover in transformer vault on 84th floor. (Lower Left) Installing TTU-50A Transmitter on 80th floor. (Lower Right) Transmission line and power conduit between 80th-84th floors. These were boxed in, plastered, and tiled.

were delivered to Empire State Building for installation about the beginning of May. All necessary water lines from the pumps to the transmitter r-f cabinets, storage tanks and heat exchangers were installed and pressure-tested before the TV cubicles were shipped.

By June, practically all of the TV equipment, including the 15 cubicles of the transmitter, transmitter control console, input and monitoring racks, slide projection equipment and the three additional video racks were shipped in trailer trucks to the building for installation.

Since no equipment could be moved into Empire State Building during the day, the trucks were timed to arrive at 6 P.M. A crew of 15 men then worked until 7 A.M. moving the equipment into the building elevators and up to the transmitter room on the 80th floor. As the cubicles reached the transmitter room they were placed in position over the wire ducts in the raised platform ready for interconnection.

Video and Monitoring Equipment

Input and monitoring racks were standard RCA equipment as supplied for UHF transmitter installations except for minor

changes which were effected in this case for added compactness and versatility. The three video racks housed the vidicon film chain amplifier and control circuits, sync generator, colorplexer, color burst generator, distribution amplifiers, power supplies and other video and test equipment.

All racks were wired and tested at RCA before shipment to the site. Some racks were delivered with equipment in place, others were placed in position first and then equipment was installed.

Control Console

The standard RCA TTC-5A Transmitter Control Console was expanded for WUHF to function as a master control position for the station. For video, two TS-2A Switchers mounted in the desk provided 18 separate input and two output lines. One switcher was used for switching video programs and was modified to switch audio simultaneously; the second switcher was used for monitoring any of the seven external video feeds, plus the signal from the vidicon film chain located in the transmitter room.

A TK-21 Camera Control and TM-6 Monitor was required for the slide projection equipment. With the addition of a BC-5B Audio Console, nine more audio channels were made available, four of which could be controlled simultaneously. With these facilities it was possible to preview, monitor and select for transmission,

FIG. 6. Start of UHF tests by FCC. Chairman Newton N. Minnow (hand on switch) officially puts WUHF on air in New York City. Behind him, left to right, are Mike Gerstein and Seymour N. Siegel, supervisor and director, respectively, of N.Y.C. station WNYC which operated WUHF.

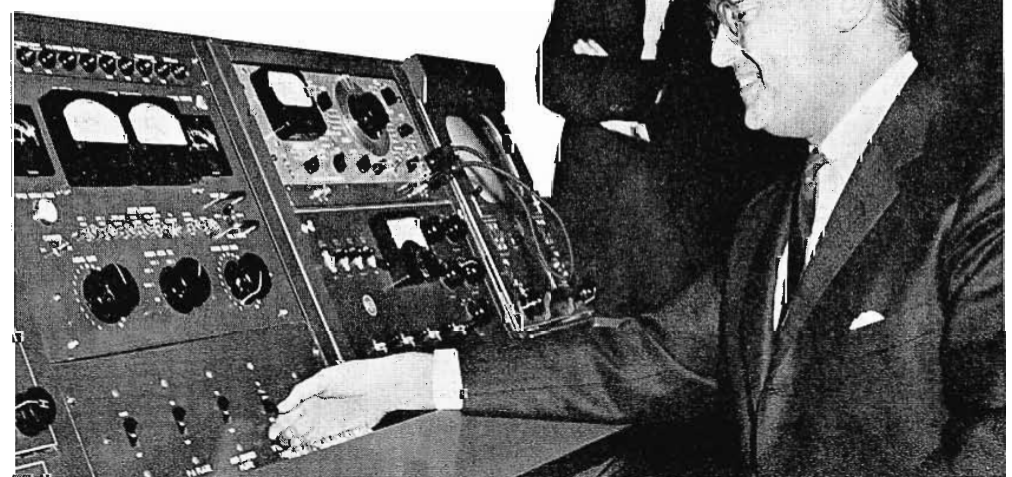

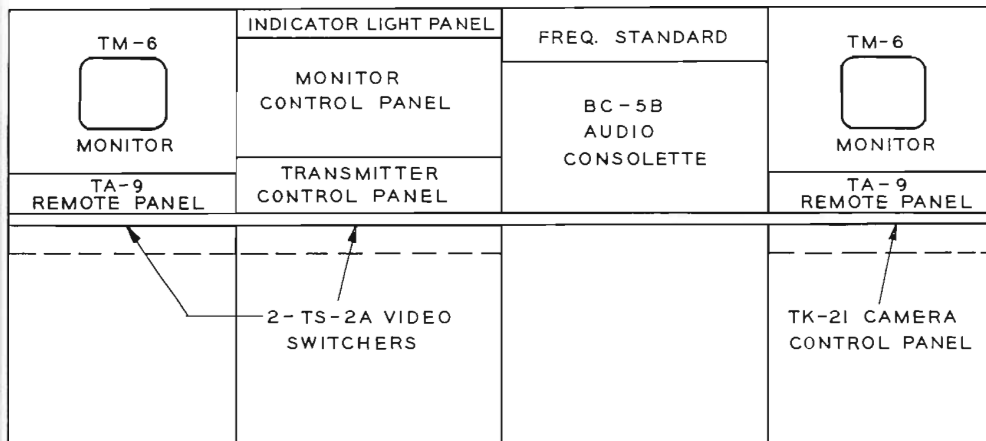

FIG. 7. Diagram of WUHF transmitter control console.

any of WUHF's several program sources in Empire State Building as well as in the WNYC TV studio.

R-F Line Components

R-f components of a high power transmitter are of course necessarily large. Due to their size and because short, direct runs are often required, most r-f components of the TTU-50A transmitter are mounted overhead. This includes line sections inter-

connecting the high power amplifiers, duplexers, harmonic filters, dummy loads, and the filterplexer which functions as a combined diplexer and vestigial sideband filter. The filterplexer in this transmitter is a waveguide type developed by RCA especially for high power use.

A two-inch copper water line was installed and connected to Empire State Building's fresh water supply to provide for cooling the dummy loads. Water cool-

FIG. 8. Transmitter output switching circuit.

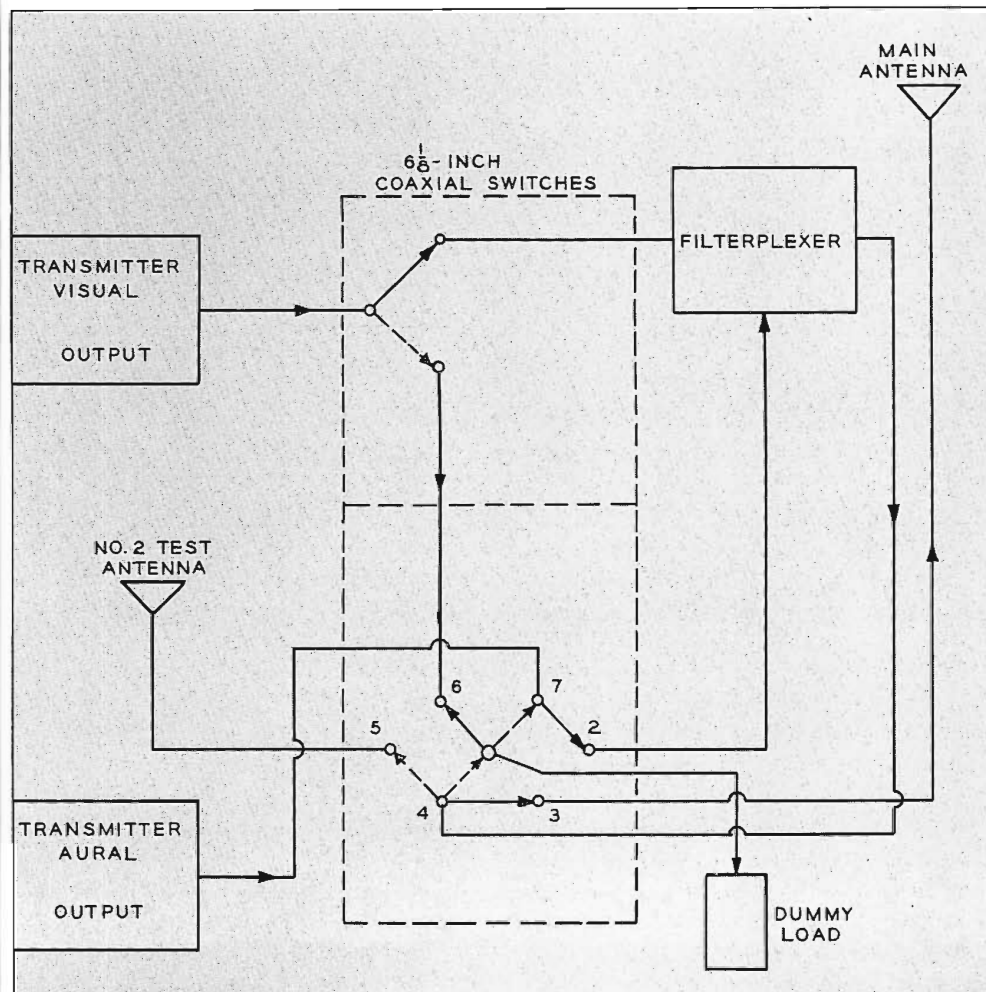

ing for reject loads was incorporated in the closed, distilled water system used for high power tubes, thereby reducing water demand.

Coaxial R-F Switches

An element of the transmitter output circuit was an r-f switching system consisting of two $6\frac{5}{8}$ -inch coaxial line patch panels to provide convenient connections for a number of test and monitoring functions.

One of the two switches was, in effect, a three-pole panel, and the other was a

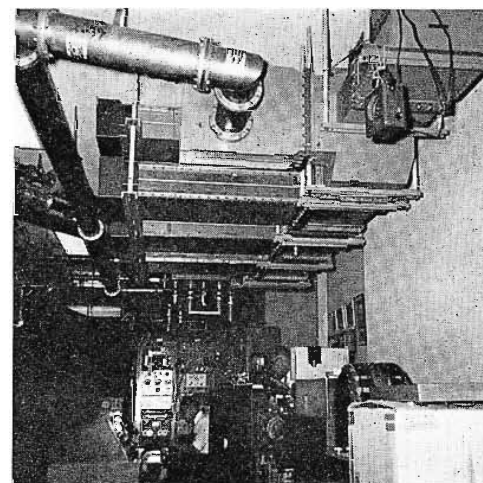

FIG. 9. Overhead installation of waveguide filterplexer.

seven-pole panel. The movable parts of the switches were constructed as jumper elements that could be quickly clamped into selected positions for the connections desired. Used in combination, the switches provided for the following functions: separate dummy load testing of aural and visual transmitters; switching between main and standby antennas; by-passing the filterplexer for special tests; and connecting the transmitter into the dummy load either before or after the filterplexer.

WUHF Programming

TV studio equipment acquired by WNYC from RCA for use in WUHF programming was installed in an area formerly used as an AM studio in the Municipal Building. Programming consisted of a limited number of studio and remote field pickups of educational and cultural material within New York City which was recorded and later fed into the system together with special 16 mm film selections.

A large part of the station's programming was obtained from TV stations operating in Empire State Building which were interconnected with WUHF for the purpose. TV slide projection equipment installed in the transmitter room was used for station identification during the tests.

MTV PIONEER BLENDS CULTURE, CIVICS FOR GOTHAM VIEWERS



FIG. 1. This was the scene in Gracie Mansion, official residence of New York's mayor, last November 1 when WNYC-TV received its license from the FCC. From left are FCC Chairman

Newton N. Minow, Mayor Wagner, FCC Commissioner Robert E. Lee, Seymour N. Siegel, Director, and John DeProspero, Executive Officer, of city's Municipal Broadcasting System.

In New York City and environs a TV viewer with a UHF receiver can tune in programs never seen elsewhere. He can, for example, watch a policeman frisk a suspect in a highly-professional manner, or observe how a city fireman scales a ladder, or share a postgraduate course for physicians.

But he can't watch another "show" which is frequently dramatized in the movies: the New York City Police Department's daily line-up. It too is on Channel 31, four times a week, but an encoder in

the camera chain makes a mish-mash of the home viewer's picture. Reception thus is limited to the precinct station houses, where receivers are equipped with unscramblers, and only the police can study the parade of suspects.

Such unusual programming is typical of municipal television, or MTV as it has been dubbed, a new kind of non-commercial broadcasting service represented by a single station, WNYC-TV, owned and operated by the City of New York.

Seymour N. Siegel, who as Director of Radio Communications for the Municipal Broadcasting System is operating head of WNYC-TV, describes the station's niche in television as one of "civics plus culture." And he feels that while it is involved in educational TV of a sort the municipal station is better categorized as "instructional television."

Channel 31 became the nation's first non-commercial municipal station last November 1st when FCC Commissioner Robert E. Lee presented the station's license to

New York's Mayor Robert F. Wagner. Previously it had been WUHF, the FCC's experimental UHF station which took to the air November 29, 1961, and had been simulcasting programs from New York's six commercial TV stations.

With the transfer, the city took over the Empire State Building transmitter which RCA had built and installed for the year-long UHF test. And the fledgling WNYC-TV began operations from two small (27-by-41-feet) studios on the 25th and top floor of the Municipal Building in downtown New York. Its studio equipment consists of two RCA TK-60 cameras, one TRT-1B television tape recorder, a TK-21 film chain and a switching system.

The Police Department's programs, which are largely instructional and designed to help the bluecoats do a better job or to advance in grade, were begun during the FCC experiment. They reach 81 precinct station houses and are repeated three times weekly to cover the three police platoons, or shifts.

In addition to training programs and the line-up, men in the precincts watch a special on the city's "13 Most Wanted Criminals" and a daily five-minute program of police news. Mr. Siegel estimates that broadcasting the line-up saves at least 1,000 man hours weekly by eliminating detectives' travel from precincts to police headquarters. Moreover, a larger number of police officers can observe the parade of suspects.



FIG. 2. WNYC-TV was only a few days old when its staff tackled the heavy organizing job of preparing visuals of Election Night returns. Here the news camera catches the scene as first returns arrived in the studio.

Another large segment of WNYC-TV's viewers is made up of city firemen. With UHF receivers in 280 firehouses, instructors can reach approximately 5,000 firemen with training programs and demonstrations on some phase of the fire-fighter's work. In pre-TV days, an entire year was required for an instructor and his paraphernalia to tour the firehouses and reach the

same audience that now views the televised course during a half hour.

While much of Channel 31's programming is directed to city employees, there is nothing to prevent householders from tuning in. And Mr. Siegel has evidence from viewer response that many do. The Fire Department programs, for instance, include an evening audience of some 50 fire

FIG. 3. System for scrambling broadcasts of police line-ups.

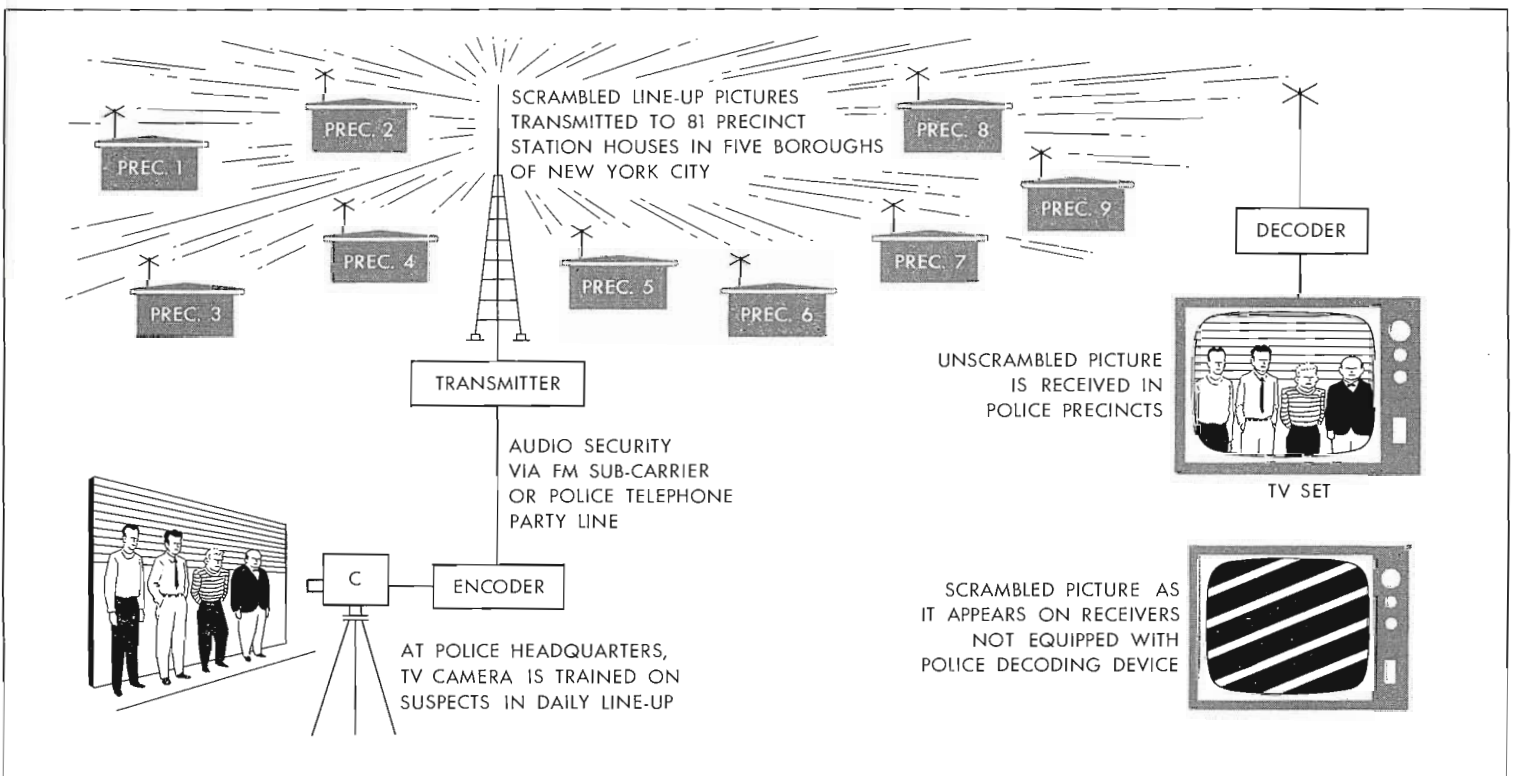

companies, most of them volunteer units, in suburban communities outside New York City.

One of WNYC-TV's most popular programs was the "gavel-to-gavel" coverage of last fall's United Nations' General Assembly session. The city's radio station, WNYC, which has been on the air since 1924, also provides full coverage of all United Nations sessions.

In another area, nurse-training, the station has broadcast a series of lectures on the legal aspects of nursing and reached nearly 3,000 nurses in 38 Municipal Hospitals. The city's Department of Health also has been presenting a three-times-weekly program on nutrition. The series for doctors, with a potential audience of some 23,000 members of the medical profession, has begun on a weekly basis.

Channel 31 is on the air from 9 a.m. to 11 p.m. daily and originates much of its programming from film and tape. Currently it is carrying about four hours of color programs daily from NBC and ABC as part of a coverage test being conducted by the Association of Maximum Telecasters. The tests will be concluded in April.

The Municipal Broadcasting System, which includes the TV operation, also is responsible for all of the city's two-way

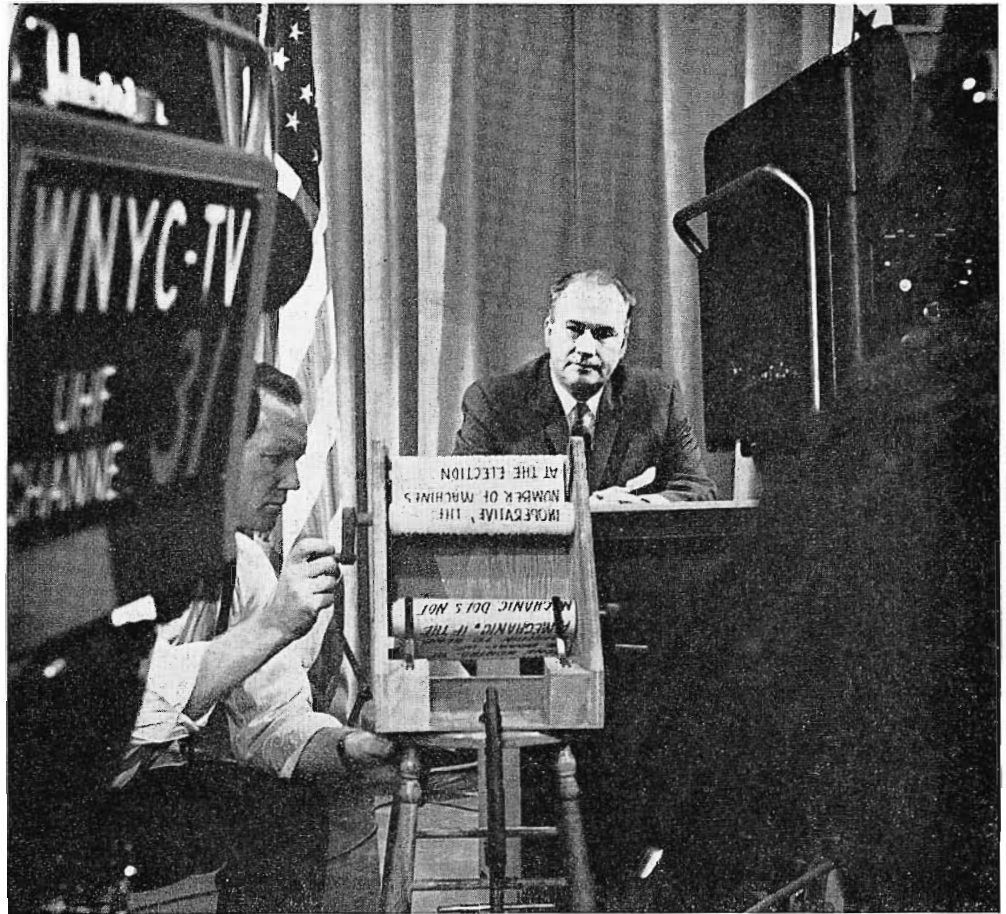

FIG. 4. Police Commissioner Michael J. Murphy uses a hand-powered prompter, C-clamped to kitchen stool, for election eve briefing televised to precinct houses.

FIG. 5. In program series on good eating habits, Barbara Primo, nutritionist with N.Y.C. Department of Health gives Channel 31 viewers tips on foods and menus.



communications systems except those used by the police and fire departments. The System also provides audio recording service for City Council, Board of Estimate and other meetings. It runs an extensive PA service for city departments and functions and maintains a training film production unit which is being expanded to provide TV film news for broadcast.

The city System, which has a staff of 156 people, also provides around-the-clock recorded telephone reports of traffic conditions, storm effects and other emergencies. New Yorkers get the information by dialing an easy-to-remember number: 999-1234. Last fall during a hurricane the service logged 648,000 calls in a two-day period. Normal load is about 200,000 calls a month.

But it is in the new field of municipal television that Mr. Siegel, now in his 30th year as a municipal broadcaster, sees "virtually limitless" opportunities for public service. To the 75,000 to 80,000 households in the viewing area equipped for UHF, this will mean more programs de-

FIG. 6. With no budget money for performers, station uses city officials, its own executives before cameras.

scribing work of city departments and more televised meetings of city legislative bodies. Since the station has no budget for programs, Mr. Siegel plans to use as performers talented students in the city's dramatic, music and dance schools.

Municipal television's prime responsibility, in Mr. Siegel's view, is to give the public a better understanding of how local government functions. And to do so, WNYC-TV will identify areas where it feels neither commercial nor educational television can fulfill public needs. Thus television is heralded as a new and direct means of improving a city's communications with its citizens.



FIG. 7. Station's control room is twenty-five stories up, on top floor of New York's Municipal Building near City Hall. Equipment includes an RCA TRT-1B television tape recorder shown here with John DeProspro, (left), Executive Officer, Municipal Broadcasting System, and Thomas Fisher, who is Chief Supervisor for WNYC-TV.

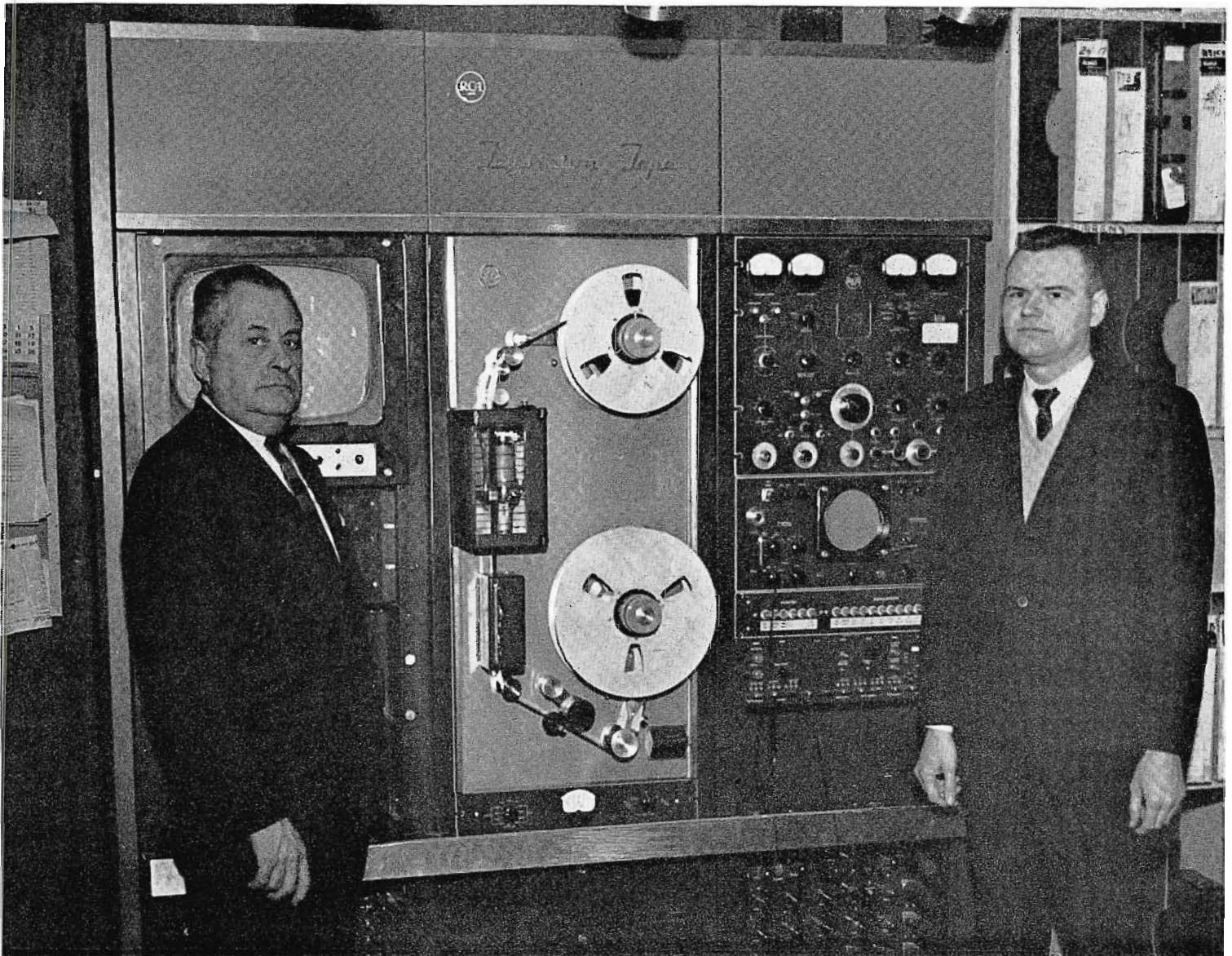

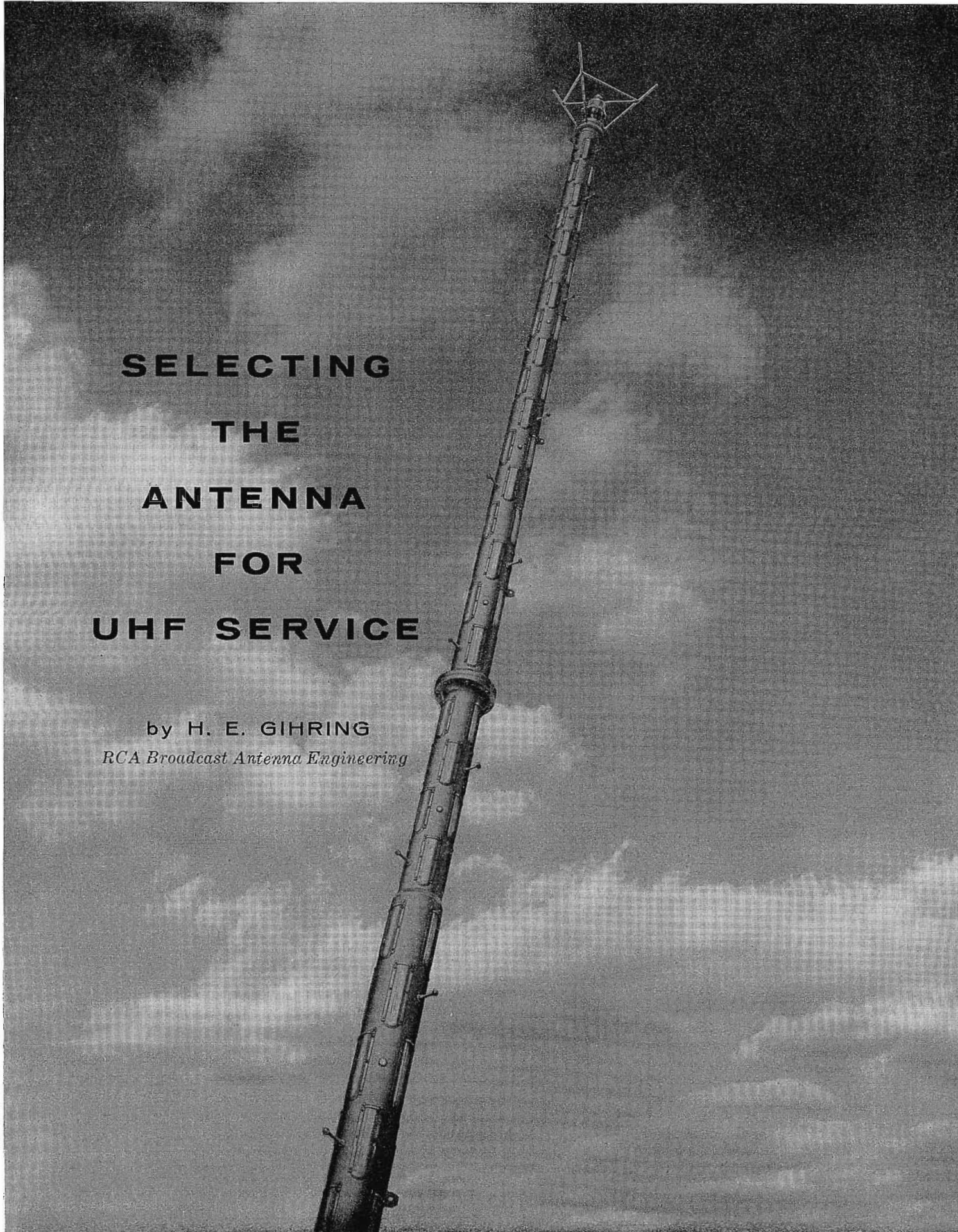
A tall, slender antenna tower, likely a whip antenna, is shown against a cloudy sky. The tower is composed of several sections and has a complex structure at the top. The text is centered on the left side of the image.

**SELECTING
THE
ANTENNA
FOR
UHF SERVICE**

by H. E. GIHRING
RCA Broadcast Antenna Engineering

In order to meet the demand for UHF service, RCA has designed a new line of antennas, based on the slotted cylinder approach. This is ultimate in antennas for UHF service since it combines the functions of a supporting mast and those of a radiator with no resultant pattern degradation. There are no projecting parts that can be damaged by ice, or are subject to lightning strikes. Furthermore, the slotted cylinder antenna has practically no vertical polarization to detract from the overall efficiency of the antenna. These antennas are designed to be insensitive to ice and snow effects, since the combination of the upper and lower halves of the antenna tend to balance out such effects.¹

The accompanying Table I gives a brief description of the new line of UHF antennas. Each of the parameters listed in this table has a bearing on the coverage that will be obtained. Following is information with respect to each of these parameters which will enable the best choice to be made for a given set of conditions.

Gain

The product of gain, transmitter power and transmission line efficiency determines the effective power radiated (ERP) which, in turn, directly affects the field strength produced at various distances. Three general values of gain are provided, namely 6, 27, and 46. The ERP achievable with each gain value when the maximum power input is used is shown in the table. The gain-of-6 antennas can also be used for stand-by purposes.

Vertical Pattern

The vertical pattern depicts the relative voltage radiated at various angles above and below the horizon. The gain determines the width of the vertical pattern in degrees, measured across the main beam at the 70.7 per cent voltage point (3 db). This is defined as the vertical beam width. A simple relationship states that the vertical beam width is approximately 60 divided by the gain for an omnidirectional antenna. Thus an antenna with a gain of 25 will have a vertical beam width of about 2.4 degrees, and a gain of 50 antenna will have a beam width of about 1.2 degrees. The increased gain results from the more concentrated beam.

In utilizing a higher gain antenna due consideration must be given to the local coverage. Figure 2 shows the relative field

¹ A de-icing system is available for use in areas where icing is likely to be severe.

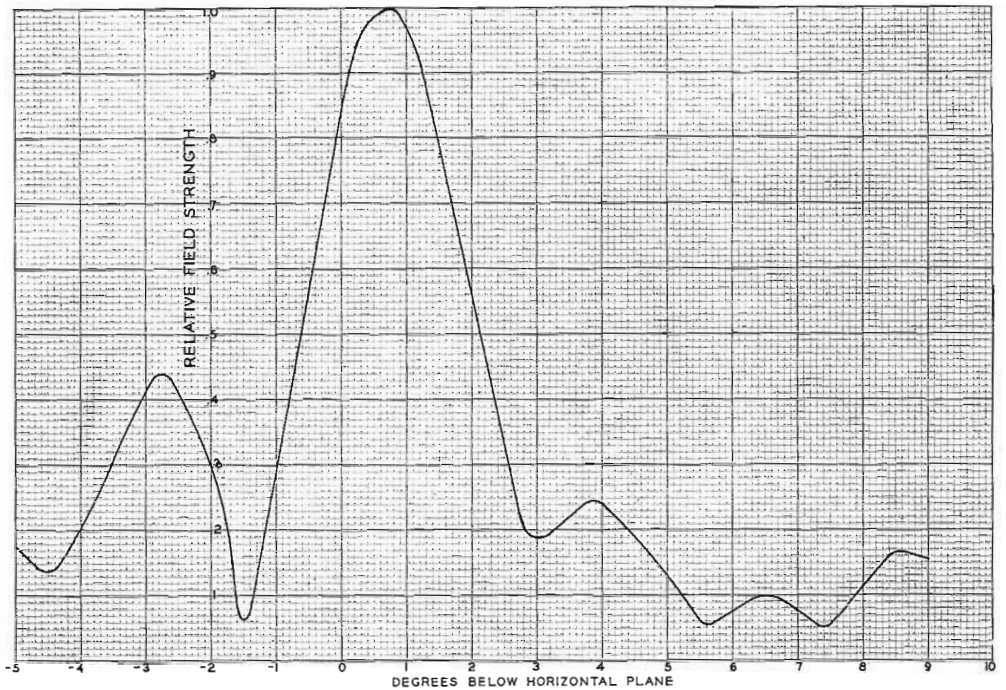

FIG. 1. TFU-24DL antenna with a 0.75 degree beam tilt. This pattern was used to obtain Curve (1) of Fig. 2. The pattern is null-filled, which means that the location of the nulls are still discernible but are filled by positive means to a given percentage. Major lobe power gain is 20.5.

TABLE 1 Characteristics of RCA Slotted-Cylinder UHF Antennas

Type No. TFU-	Channel Range	Gain	Power ¹ Rating, KW	Vertical ² Pattern Type	Achievable ³ ERP, KW
Omnidirectional Antennas					
6B	14-60	6	15	Filled	90
21DL	14-30	21 ⁴	15	Filled	315 ⁴
24DL	14-30	24 ⁴	15	Filled	360 ⁴
24DM	31-50	24 ⁴	13.5	Filled	324 ⁴
27DH	51-83	27 ⁴	12.5	Filled	337 ⁴
27K	14-40	27 ⁴	110	Filled	2970 ⁴
27J	14-30	27 ⁴	45	Filled	1215 ⁴
27J	31-55	27 ⁴	40	Filled	1080 ⁴
27J	56-83	27 ⁴	36	Filled	972 ⁴
25G	14-55	25	75	Shaped	1875
25G	56-83	25	40	Shaped	1000
46K	14-40	46	110	Shaped	5000
46H	41-55	46	70	Shaped	3220
46H	56-60	46	48	Shaped	2208
46H	61-83	46	40	Shaped	1840
Directional Antennas					
24DA Series	On Application	On Application	12.5-15 ⁵	Filled	6
26DAS Series	On Application	On Application	40-60 ⁵	Filled	6

¹ Based on 40 C ambient, multiply rating by 0.8 for 50 C ambient.

² See RCA UHF Pylon Antenna Catalog for patterns and other data.

³ Product of gain and input power rating of antenna. No line losses included.

⁴ Gain stated is for 0 degrees beam tilt. To determine gains for other beam tilts, see Vertical Patterns in RCA TV Antenna Catalog.

⁵ Depends on channel.

⁶ Depends on horizontal gain which may be of the order of 1.5 to 2.5 depending on diameter over wavelength ratio and pattern shape.

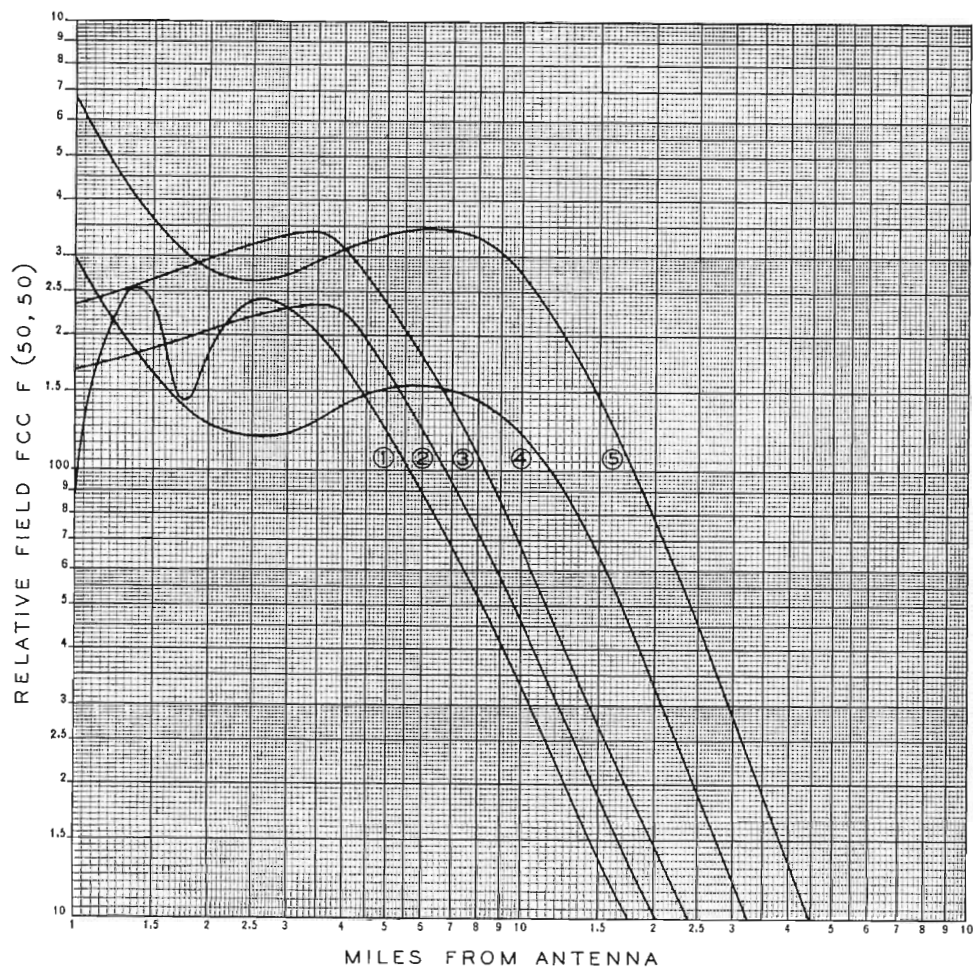

FIG. 2. The effect of gain, elevation, and ERP on coverage¹.

Curve No.	Antenna ²	Gain	Beam Tilt	Elevation	ERP KW
(1)	TFU-24DL	20.5	0.75	500	225
(2)	TFU-46K	46	0.75	500	500
(3)	TFU-46K	46	0.75	500	1,000
(4)	TFU-46K	46	0.75	1,000	1,000
(5)	TFU-46K	46	0.75	1,000	5,000

Curves (1) and (2) show the relative fields when a TFU-46K replaces a TFU-24DL with the same 12.5 KW transmitter at 500 feet.

Curve (3) shows the relative field with the TFU-46K antenna and an increase in transmitter power to 25 KW.

Curve (4) shows the relative field with the TFU-46K antenna and a transmitter power of 25 KW with an increase in height to 1,000 ft.

Curve (5) shows the relative field with the same conditions as (4) except with an ERP of 5,000 KW.

¹ See footnote 2, this article.

² The same results apply for antennas with similar gains and vertical patterns.

Based on these curves, a few general observations can be made:

1. For local coverage, a combination such as (1) can be used.
2. The service radius can be increased by raising antenna gain, raising transmitter power, or raising height.
3. When raising antenna gain the effect on local coverage should be studied; if it is lower an increase in transmitter power is also necessary.
4. When raising height, especially with a high gain antenna, the transmitter power must be increased.

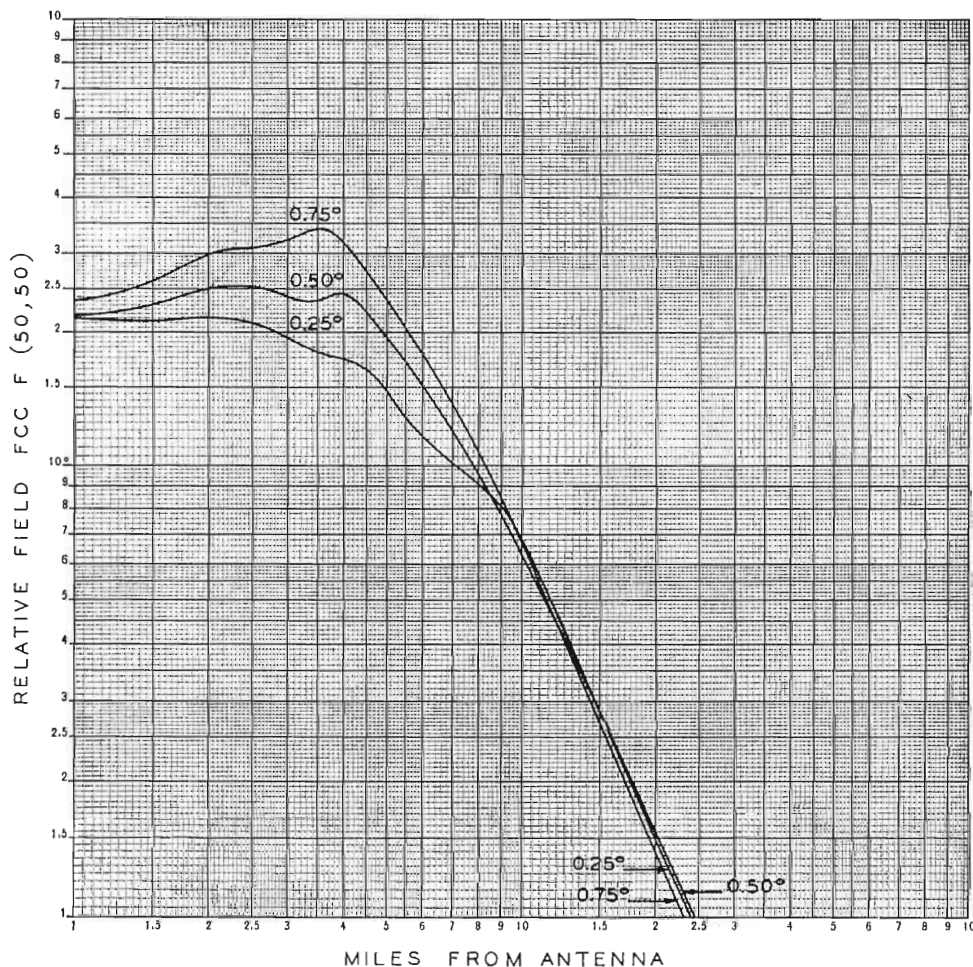

FIG. 3. The substantial increase in local coverage and the negligible loss at the horizon is shown in these three curves. The curves are for a TFU-46K (gain 46) antenna radiating one megawatt. The elevation is 500 feet and the radio horizon is 31.6 miles at an angle of 0.343°.

vs. distance² for five sets of conditions with some general conclusions. Above all it is essential that any change made to an existing installation does not reduce the field strength in any part of the service area. Experience has shown that this almost invariably results in dissatisfied viewers.

Two general types of vertical patterns are provided, namely the null filled (see Fig. 1) and the shaped pattern (Fig. 6). In the shaped pattern, the amplitude and phase of each successive layer is varied in accordance with a computed pattern synthesis to produce this desired shape. Six of the 17 antennas listed in Table I are of

² The studies are based on the FCC F(50,50) curves and are not applicable for any given situation since terrain can influence the values up to 20 db or more. (See statement concerning their application in FCC's Sixth Order and Report par. 3.683). They are used for comparative purposes only in order to bring out certain facts which will aid in choosing the best combination of parameters for certain conditions.

this type. The balance of the antennas are null filled. These antennas are simpler to build and hence less costly. However, in most cases they provide highly acceptable coverage (curve 1 in Fig. 2).

Beam Tilt

Since beam widths at the 3 db point are of the order of 1 to 2 degrees, it is highly desirable to utilize the radiated power most effectively. The accompanying Table II shows the angle and distance to the horizon for various antenna heights assuming a smooth 4/3 earth. It should be noted that for 1000 feet above terrain, the angle to the horizon is almost 0.5 degree. If no beam tilt were employed, over half of the main lobe or most of the energy would be aimed above the service area. This can be seen by inspection of the vertical pattern of the 46K antenna. In general, it is desirable to use a beam tilt which is one-quarter to one-half degree greater than the depression

angle to the horizon (value in Fig. 2). An inspection of the vertical patterns will show that the amount lost at the horizon is only a fraction of a db. However, the gain in the local service area could be appreciably more. This is shown in the three curves in Fig. 3.

The 0.75 degree beam tilt is 0.4 degree more than is needed to reach the horizon. While the increase in local coverage is substantial, the reduction at the horizon is minor. There is a tendency to be concerned about the drop in ERP in the horizontal direction as beam tilt is increased. This situation must be weighed against the loss of local coverage.

Horizontal Pattern

Accompanying Figs. 4 and 5 show some typical horizontal patterns that can be obtained with slotted cylinder UHF antennas. Other patterns are also available. When a horizontal pattern of this type is used, a

horizontal gain as well as vertical gain is obtained. Hence the ERP in the maximum direction is the product of the transmitter power times the vertical antenna gain times the horizontal pattern gain times the transmission line efficiency.³

The ERP value in favored directions can be roughly doubled by using a horizontal pattern of the type shown. Values up to 2.6 can be obtained if the horizontal beam is narrowed further. Such antennas are useful when the antenna is located near a body of water over which no radiation is desired, or on top of a mountain range over-looking a valley where little or no radiation is desired over mountainous territory in back of the antenna or for other special conditions.

³ This relationship holds only if the vertical gain is the same in all azimuthal directions. This is generally true for slotted cylinder antennas, but may not be true for other types.

TABLE II
DISTANCE IN MILES TO RECEIVING LOCATION AND DEPRESSION ANGLES FOR VARIOUS ANTENNA HEIGHTS

H—Height in feet to Electrical center of antenna
 D_h —Distance to horizon = $\sqrt{2H}$ (4/3 earth radius)
 A_h —Depression angle to horizon = $\frac{.0216H}{D_h}$

The relationship $D = \frac{.0109 H}{A}$
 holds to right of staggered line in table below within 4%

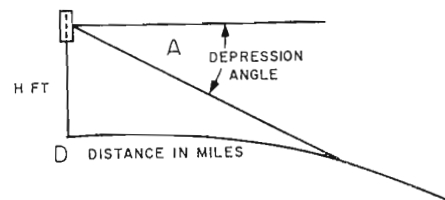

HEIGHT H IN FEET	D_h	A_h	DEPRESSION ANGLE																			
			0.5°	1°	1.5°	2°	2.5°	3°	3.5°	4°	4.5°	5°	6°	7°	8°	9°	10°	11°	12°	13°	14°	15°
200	20.0	.216	4.6	2.21	1.45	1.07	0.86	0.71	0.61	0.54	0.48	0.43	0.36	0.31	0.27	0.24	0.22	0.20	0.18	0.17	0.15	0.14
300	24.5	.268	7.2	3.35	2.18	1.64	1.30	1.07	0.92	0.80	0.71	0.64	0.55	0.46	0.41	0.37	0.33	0.30	0.27	0.25	0.23	0.21
400	28.3	.304	9.9	4.49	2.90	2.18	1.75	1.42	1.24	1.06	0.94	0.86	0.73	0.62	0.54	0.49	0.46	0.40	0.36	0.33	0.31	0.29
500	31.6	.343	12.6	5.60	3.65	2.72	2.16	1.82	1.55	1.36	1.21	1.09	0.92	0.78	0.68	0.61	0.55	0.50	0.45	0.42	0.39	0.36
600	34.6	.375	16.0	6.81	4.8	3.61	2.64	2.15	1.86	1.63	1.42	1.31	1.09	0.92	0.81	0.73	0.65	0.59	0.54	0.50	0.46	0.43
700	37.4	.405	19.9	7.98	5.2	3.87	3.08	2.54	2.16	1.90	1.68	1.50	1.25	1.06	0.94	0.83	0.74	0.68	0.62	0.57	0.53	0.50
800	40.0	.435	24.2	9.2	5.9	4.49	3.52	2.89	2.50	2.17	1.90	1.75	1.45	1.22	1.05	0.97	0.86	0.78	0.72	0.67	0.61	0.58
900	42.4	.452	29.5	10.5	6.7	5.05	3.98	3.28	2.80	2.45	2.13	1.96	1.62	1.36	1.19	1.09	0.97	0.88	0.81	0.75	0.69	0.65
1000	45.0	.487	36.2	11.6	7.4	5.51	4.39	3.65	3.10	2.70	2.39	2.15	1.79	1.52	1.32	1.18	1.08	0.98	0.90	0.83	0.77	0.72
1200	49.0	.530	—	14.1	9.0	6.75	5.32	4.39	3.77	3.19	2.85	2.61	2.15	1.81	1.59	1.44	1.29	1.18	1.08	1.00	0.92	0.87
1400	53.0	.577	—	16.7	10.4	7.66	6.12	5.13	4.33	3.77	3.35	3.00	2.48	2.11	1.85	1.63	1.45	1.36	1.24	1.15	1.06	1.00
1600	56.6	.620	—	19.4	12.0	9.10	7.10	5.85	5.02	4.35	3.80	3.40	2.84	2.40	2.13	1.91	1.72	1.55	1.44	1.32	1.23	1.16
1800	60.0	.650	—	22.3	13.6	10.25	8.00	6.60	5.65	4.90	4.30	3.90	3.19	2.69	2.39	2.15	1.94	1.75	1.62	1.48	1.38	1.30
2000	63.2	.683	—	25.4	15.4	11.25	8.89	7.30	6.25	5.45	4.80	4.30	3.60	3.04	2.68	2.38	2.13	2.00	1.83	1.70	1.56	1.46
5000	100.0	1.080	—	—	42.9	29.5	22.80	18.75	15.85	13.75	12.10	10.90	9.01	7.75	6.73	6.00	5.40	4.90	4.50	4.15	3.84	3.60

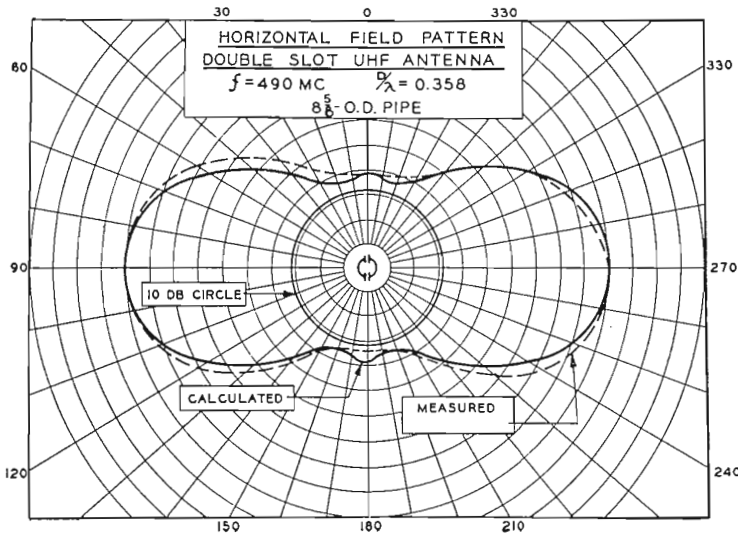

FIG. 4. Typical horizontal "Peanut" pattern obtained with RCA UHF antenna.

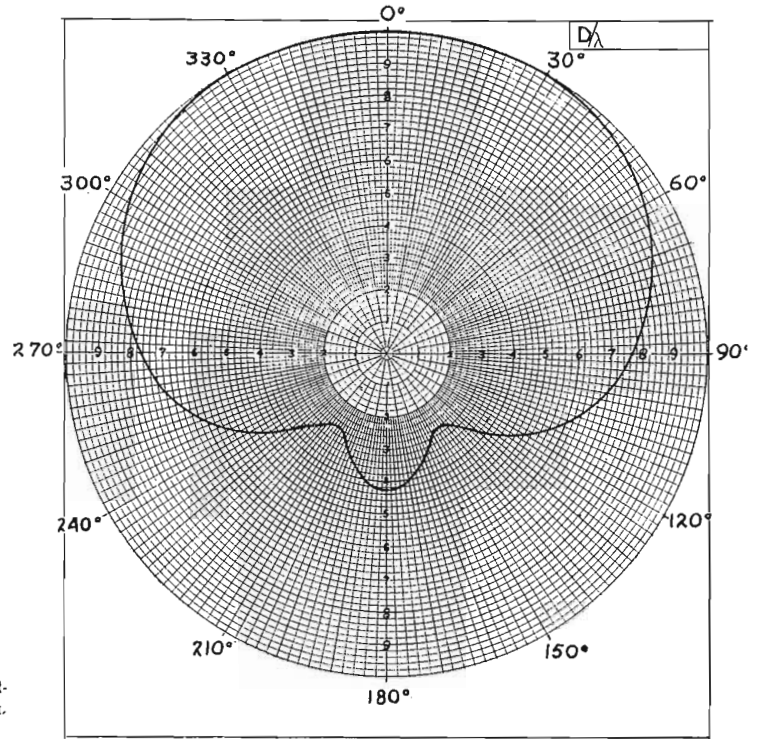
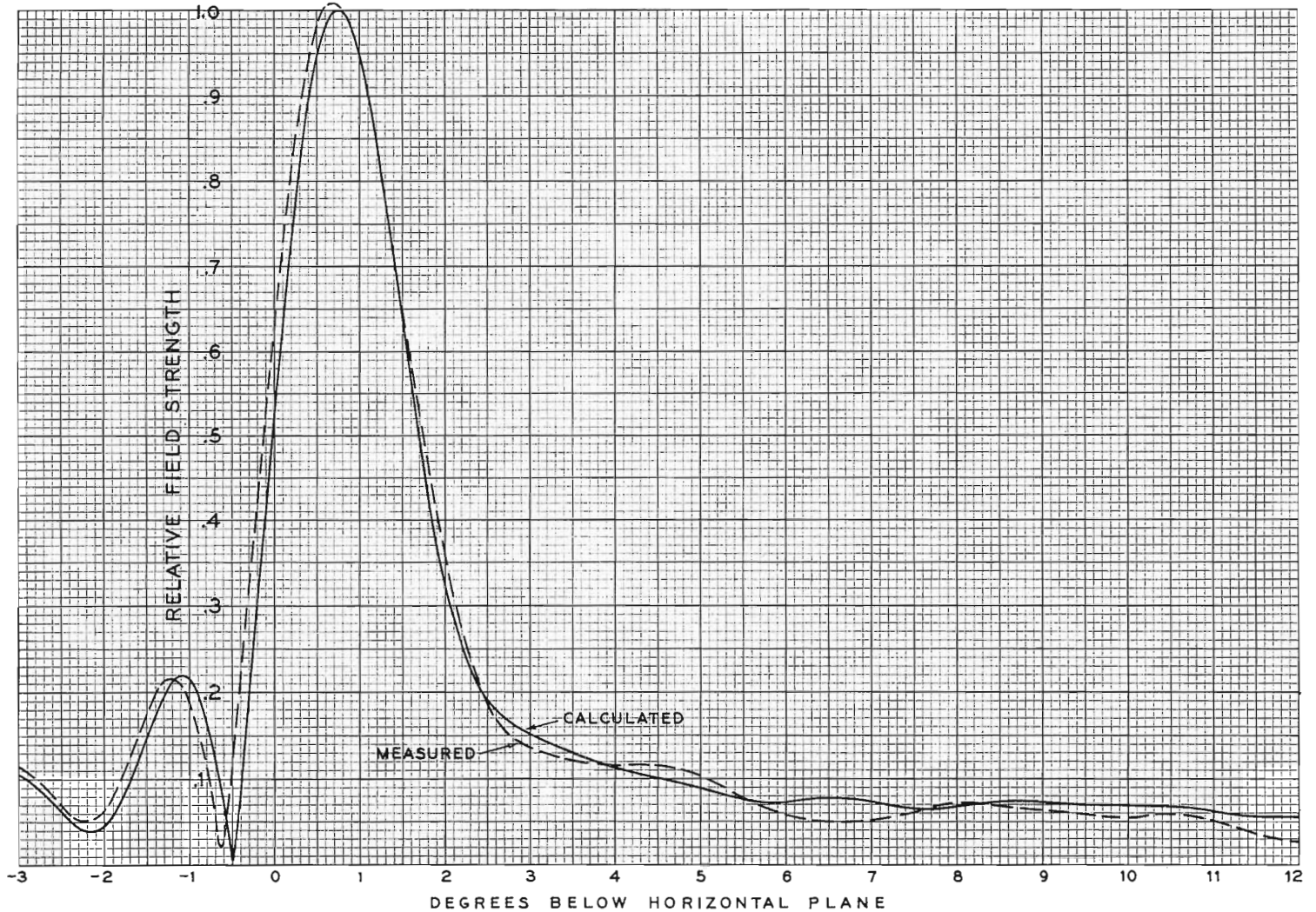

FIG. 5. Typical horizontal "Skull" pattern obtained with RCA UHF antenna.

FIG. 6. Calculated and typical measured patterns of the TFU-46K antenna installed at WSBT. The antenna was built with a 0.75° beam tilt.



The use of electrical and mechanical tilt when used on a mountain range permits the main vertical and horizontal beam to be aimed at the center of the service area immediately below the mountain. At plus and minus 90 degrees azimuth from a favored direction only the electrical tilt is obtained. Intermediate values are obtained in between. This is ideal for covering certain areas like the San Joaquin Valley in California with the antenna on the Sierra Range. Directional antennas are more attractive at UHF since the upper ERP limit is usually not a limitation as at VHF.

FIG. 7. A view of the 15 ton turntable supporting the WSBT 5 megawatt UHF antenna. (The RCA Antenna Test Site has recently been expanded for all weather operation.)

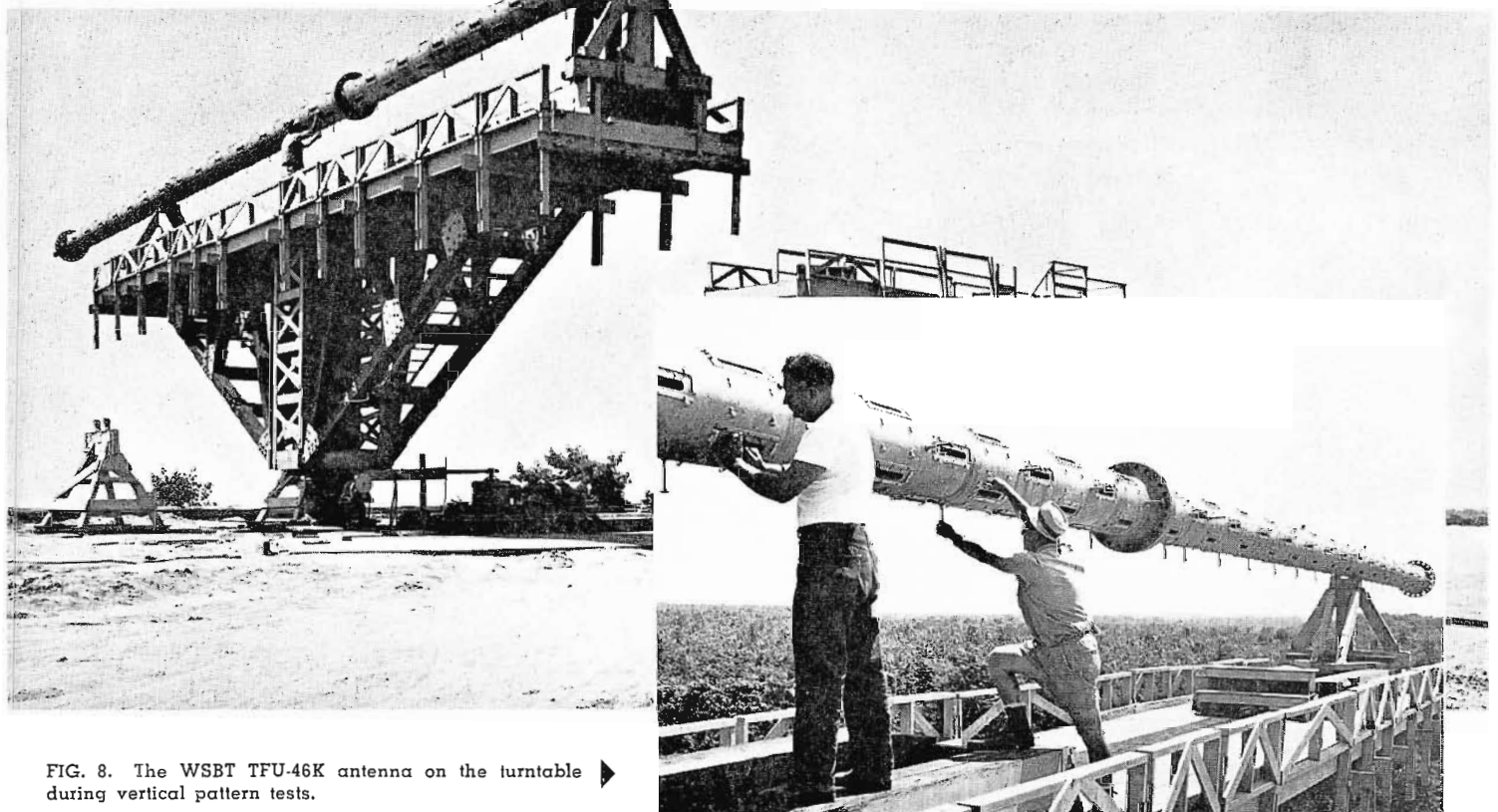

FIG. 8. The WSBT TFU-46K antenna on the turntable during vertical pattern tests.

Such directional antennas can also be side-mounted on an existing tower with the null of the antenna aimed towards the tower. In this manner the interference pattern amplitudes are reduced to the order of ± 2 db in the forward direction of the skull pattern shown.

High Power UHF

An outstanding example of UHF expansion is the newly designed TFU-46K antenna, which was installed at Station WSBT in South Bend, Indiana in August, 1962. This antenna is capable of radiating the maximum allowable power of 5 megawatts using a 150 KW transmitter.

Figures 7 and 8 show several views of this new antenna which has been in operation about 6 months. The antenna is 117 feet long, has a total of 232 slots, and weighs $13\frac{1}{2}$ tons. It is completely self-

supporting. The antenna is shown on the turntable during the vertical pattern measuring tests.

The vertical pattern, shown in Fig. 6, has a shape in which the energy below the horizon is directed to give substantially uniform field strength over the service area. Above the horizon, the energy is partially cancelled which results in a high aperture efficiency.

This pattern is achieved by varying the amplitude and phase of each successive layer in accordance with data as developed on a computer. The correlation achieved between the calculated and measured vertical pattern is shown.

The horizontal pattern is essentially circular and is within ± 1 db.

The feed system for the antenna utilizes a 9-inch transmission line which is capa-

ble of transmitting the power required for a total effective radiated power of 5 megawatts.

This antenna is an example of the planning of a forward-looking station management, preparing for the future. It appears certain that UHF is here to stay and that trends in power and radiated ERP will be continually upwards.

UHF Antenna Guide

With the advent of greatly increased interest in UHF antennas, it is felt that this information may be of benefit, especially to those who are planning new stations or modifying their present ones. While not intended to be a complete treatise on the subject, these data should prove useful for planning purposes, in order to obtain the best results from a given set of conditions.

RCA
TR-22

TRANSISTORIZED



TR-22
SOLID-STATE
TV TAPE
RECORDER



The Most Trusted Name
in Television

TV TAPE RECORDER

...for the ultimate in tape production

- DELUXE, PRECISION-BUILT, STRIKINGLY-STYLED
- BUILT-IN EXTRAS LIKE PIXLOCK AND AIR BEARINGS
- SPACE IN CONSOLE FOR ATC AND COLOR MODULES
- SIMPLIFIED, ERROR-PROOF OPERATION

For broadcasters and TV producers who require the very finest in tape equipment, the new TR-22 is the answer. Now going into stations and studios throughout the world, this deluxe, precision-built recorder includes many new features that lead to improvement in operating efficiency and picture quality. The compact design and the smartly styled console increase its usefulness, and will enhance the appearance, of any TV tape studio.

All-Transistor Design

The only tubes in the TR-22 are found in the monitor and oscilloscope. It is the only recorder that is totally transistorized in all recording and playback circuits. Among other things, the use of transistors reduces start-up time, requires less space, and increases reliability.

Five-Second Starting

Although the conservative specifications call for a warm-up period of five minutes, it has been repeatedly demonstrated that the TR-22 will playback an excellent picture in *less than 5 seconds* after it is turned on—from a cold start! This is especially important when a client suddenly appears.

Air-Bearing Headwheel

This is an exclusive RCA advantage which is standard equipment on the TR-22. Since the recording and playback heads ride on a cushion of air, there is an absolute minimum of jitter, improved SN ratio, and excellent frequency response. It all adds up to a better picture.

Built-In Pixlock

Also standard equipment on the TR-22, the Pixlock system provides for switching between tapes and other sources without roll-over, and enables you to create special effects. Other electronic editing aids include a tone oscillator for marking a cue channel. Result: A more professional production.

Finest Pictures

RCA transistor design, together with air-bearing head-wheel, assures trouble-free recording and top quality reproduction of tapes. Self-adjusting circuits hold the high quality picture over long periods of time—without an operator constantly adjusting controls. This kind of performance can be duplicated day after day, enabling you to produce the finest of tapes.

Simplified Operation

Recording controls and playback controls are built on separate panels—one at either end of the tape deck—to reduce possibility of accidental erasings, etc. Signal lights tell the operator when to start, warn him when any trouble develops, and indicate the “mode” of operation. Eye-level monitors give visual checks on performance during recording and playback.

Designed for Color

There is room in the console for adding both Automatic Timing Correction and Color. These are plug-in, transistorized modules that simply slide into position. No external equipments are required.

Self-Contained Console

All the electronics, operating equipment, and accessories are neatly packaged in a single console. There are no external racks of equipment. The TR-22 can be easily set up in one spot requiring only 10 sq. ft. of space, and is also ideal for use in a mobile unit.

YOUR BEST SELLING TOOL

Because the TR-22 is so striking in appearance and is designed to set the highest standards of excellence in TV Tape Recording, you will find it attracts attention wherever it is in operation. Your studio can benefit from this symbol of the finest in TV Tape. It's a selling tool that radiates prestige. Your salesmen and customers will be convinced that you can produce top-quality tape productions when they see the TR-22 in your studio.

See your RCA representative or write: RCA Broadcast and Television Equipment, Bldg. 15-5, Camden 2, N.J.

WBOC-TV POWER INCREASE PACES STEADY GROWTH IN UHF

Channel 16 in Salisbury (Md.), Adds 12.5 Kw Power Amplifiers to 1 Kw Transmitter, in Building-Block Fashion, and Installs UHF-Pylon Antenna on 600-Foot Tower to Boost ERP to 225 Kw

FIG. 1. WBOC-TV's TTU-12A Transmitter as it appears today. The 600-foot tower and antenna are shown in the inset.



Last Autumn, WBOC-TV increased its ERP some 15-fold by adding a 12.5-kw power amplifier to the eight-year-old TTU-1B 1-kilowatt transmitter and, by increasing antenna power gain from 17.85 to 22.5. Under the supervision of WBOC's Chief Engineer, the power-increase equipment was installed without loss of air time. One important reason for this is the building-block design of the power amplifiers. More of this later.

WBOC-TV History

WBOC-TV went on the air for the first time during 1954 as the television "arm" of WBOC, an AM station that dates back to September, 1940. WBOC started as a 250-watter with its studios and transmitter housed in a brand-new building located just north of Salisbury.

During 1947, the AM station upped its power to one kilowatt using a BTA-1L transmitter. At this time management expanded and modified the original building by increasing its size by more than 50 percent. Then, in 1956, WBOC again increased its power to make the daytime power 5 kw with 1 kw after sunset.

The venture into television in 1954 expanded the building a second time so that all operations—radio and TV—would be under the same roof. This excluded the television transmitter which was located in its own building on a 20-acre site slightly more than a mile away.

The most recent expansion of these facilities was occasioned by the increase in TV-transmitter power during the last half of 1962. The main building was enlarged by 2000 square feet and the transmitter building doubled in floor area.

WBOC Management

Organized under the name *WBOC, Incorporated*, these stations are a wholly-owned subsidiary of the *A. S. Abell Company* which also owns WMAR-TV and the Baltimore *Sun* papers. WBOC, Inc. operates as a self-sustaining enterprise under the guidance of Vice President and General Manager Charles J. Truitt.

Mr. Guy Griffen serves the dual role of Assistant General Manager and Sales Manager.

Jack W. Ward is the Director of Operations and Chief Engineer; Bernie Sparks is Production Director; Jack Downing is Program Director. Mr. Bobby Beach heads up the Accounting Department in his capacity as Assistant Secretary/Treasurer of the organization. All department heads have joint radio-TV responsibilities.

In all, WBOC, Inc. employs 55 people, many of whom have been with the Company for more than 10 years.

Location and Market

Salisbury is one of the six principal business centers of Maryland in that it turns over more than 50 million dollars a year in retail sales. The population within the city limits is approximately 20,000, however, the surrounding area more than doubles this figure.

Radio Studio

WBOC broadcasts a music-news-sports program format using an MBS (Mutual) line, "live" programming and, of course, recorded music. (The record library con-

tains more than 33,000 selections.) In addition to this programming, WBOC broadcasts the proceedings of the Selbyville (Del.) Poultry Auction via remote facilities for the edification of the poultry interests in the area. An additional completely equipped studio—including piano, Solovox and a Hammond Organ—30 miles away at Pocomoke City provides regular programming via telephone lines.

A major portion of the recorded-music shows on the station's schedule originate from the radio control room (see Fig. 9) using 70-D turntables and RT-7 Cartridge Machines. An auxiliary program-control point is located in the corner of the "live" studio.



FIG. 2. Charles J. Truitt, Vice President and General Manager.



FIG. 3. Guy Griffen, Assistant General Manager and Sales Manager.

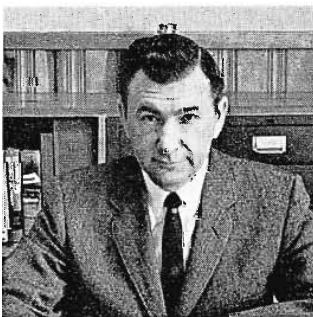

FIG. 4. Jack W. Ward, Director of Operations and Chief Engineer.

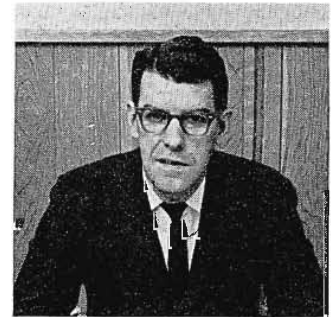

FIG. 5. Bernie Sparks, Production Director and Assistant Chief Engineer.



FIG. 6. John W. Downing, Jr., Director of Programming.

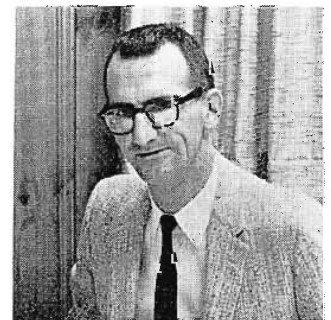

FIG. 7. Bobby O. Beach, Assistant Secretary-Treasurer.

An important part of the radio facility is the recording room. Here, via two reel-to-reel tape machines, a disc cutter, a transcription player and an RT-7 recording facility, virtually any sound-recording task may be undertaken. The recording room is connected to bridge all of the incoming program lines as well as those within the building. This permits maximum flexibility in studio use. Thus, it is a relatively simple task to record an on-air program or to record, in advance of air time, radio programming on disc, tape or cartridge. Although the cartridges usually carry spot announcements, themes and other short recordings, long-playing cartridges permit 30-minute recordings or multiples thereof. The trip-cue feature of the RT-7 extends this 30-minute program time to 60, 90 or more minutes by automatically tripping a second machine on cue.

Radio Transmitter

WBOC operates 5 kw daytime at 960 kc and cuts back to 1 kw for nighttime operation using separate patterns. The 5-kw transmitter is a Type BTA-5H while the 1-kw system is a BTA-1M, one serving as the standby for the other and vice versa, depending on the time of day.

The antenna-phasing equipment was built by WBOC engineering personnel and uses r-f contactors to switch from one pattern to the other in addition to switching a dummy load from one transmitter to the other at cutback time. An important feature is that either transmitter can be connected to one pattern or the other by a single push of a button.

The transmitter-control console, shown in Fig. 10 was also designed and built by WBOC engineering personnel.

TV Studio

In addition to broadcasting the programs of all three TV nets, WBOC-TV generates a considerable portion of the programs on its schedule, both live and film.

Film Studio

The projection room is equipped with two multiplexed-vidicon camera islands providing two separate 16-mm projectors, two 2-by-2 slide projectors and an opaque projector (Telop). This room also houses the racks of equipment associated with the vidicon cameras as well as the rack equipment for the two TK-11 image-orthicon cameras used in the "live" studio and the switching gear controlled from the video control room (see Fig. 11).



FIG. 8. Simplified drawing of the offices/studio building. Expanded three times since originally built, the additions have extended the center corridor for smooth traffic flow. The building houses all station facilities except for the TV transmitter which is located on a separate site slightly more than a mile away.



FIG. 9. Main Radio Control. Dave Beuret holds a record cue on the turntable.

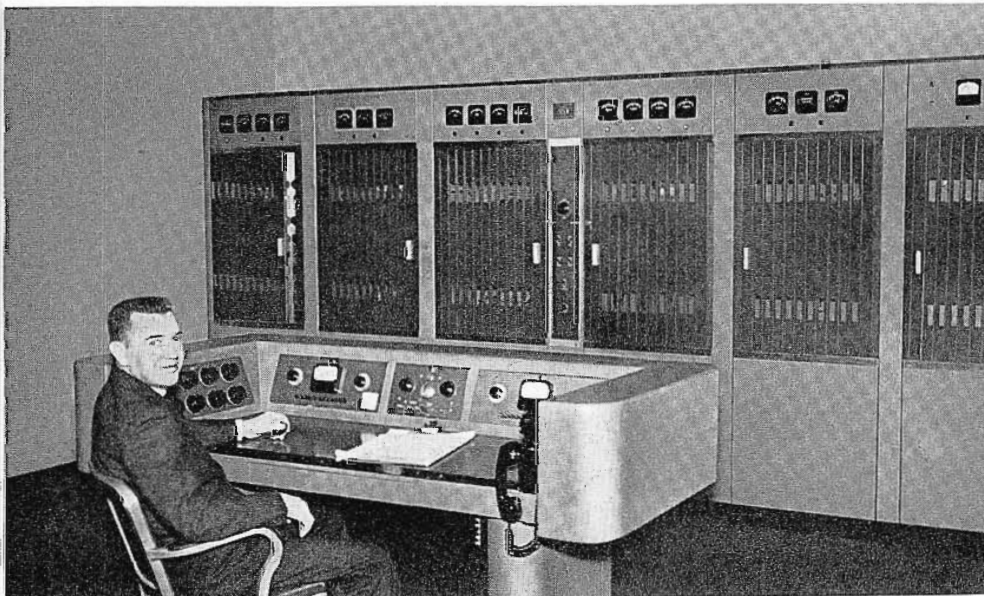

FIG. 10. The AM-transmitter facility. The cabinet at the far left houses the 1-kw (BTA-1M) nighttime transmitter and the next four house the 5-kw (BTA-5H) daytime transmitter. Cabinet at far right contains the antenna-phasing equipment. Transmitter Supervisor Roy Horsman at the console.

The double-multiplex film system provides an extra measure of filmed-programming flexibility aside from the obvious advantage of full-standby film gear.

Live Studio

As it should be in an efficient setup, the largest room in WBOC-TV's building is the live-TV studio. Providing more than 2000 square feet of floor area (including half of the prop-storage area), WBOC's studio floor is at grade level thus eliminating the necessity for ramps to the outdoors. A

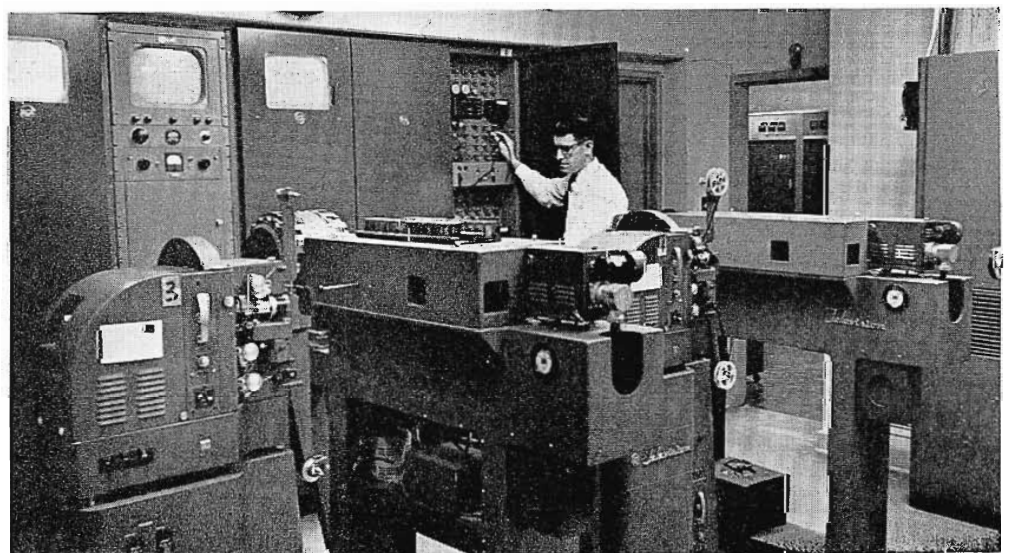

FIG. 11. Film Projection Room. Two multiplexed-vidicon camera islands provide extra program flexibility as well as full standby. Ass't Chief Bernie Sparks makes a routine check.

12-foot, overhead door between the studio and parking lot permits the use of large props (automobiles, farm tractors, etc.) on stage without handling problems.

Pre-Arranged Lighting Control

An unusual feature of the studio is the lighting arrangement. Designed and built by WBOC people, the lighting grids have been wired to provide maximum flexibility without complication. To illustrate, there are eight separate lighting circuits (two groups of four) that permit split-second switching of the lighting setup from one set to another. The obvious advantage in this is the reduced air-conditioning load since only the lights in actual use need be in operation. The switching arrangement allows lighting changes from the studio floor without physical movement of the scoops, spots, etc. In addition to the floor-located control panel, a duplicate panel is located at the video-control location in the control room as a backup for the floor-men's panel.

Two TK-11 image-orthicon cameras serve for all "live" pickups, even during five back-to-back educational-TV shows aired during the afternoon of every weekday in addition to the seven back-to-back programs aired between 6 and 7:15 p.m. daily.

WBOC's stage hands are completely free of intercom-cable encumbrances through the use of a novel "radio-hat" system. (See Fig. 13). The transistor receiver is encased in a 16mm film can mounted at the "peak" of the hat with its loop antenna wound in the "brim". The transmitter is a miniature modulated-oscillator (phono-



FIG. 12. WBOC-TV's two TK-11 Cameras pick up the contestants for the "Miss Maryland" Crown.



FIG. 14. Video Control. Five TM-6 Master Monitors are mounted in the console. The screen in the upper left displays the air signal. Video Supervisor John Raymond prepares for a switch.

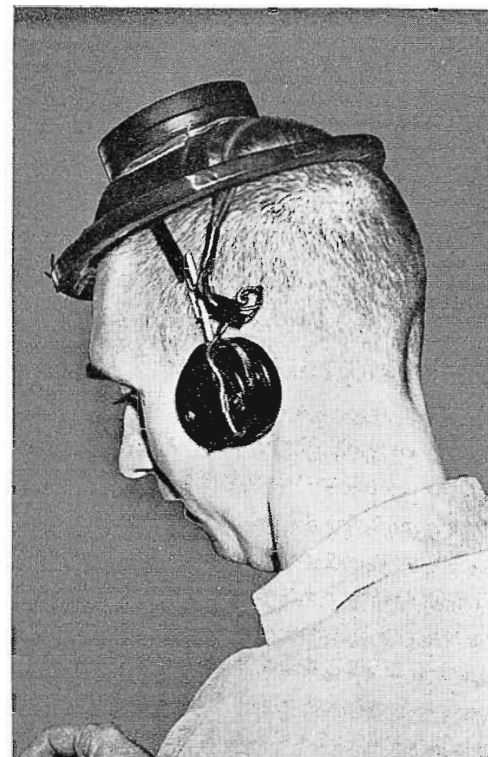

FIG. 13. WBOC-TV's "radio hat"—a station-fabricated device that permits one-way communication between control room and the studio floormen. The transistron receiver is in the 16-mm film can at the "peak" with the loop antenna in the "brim".

oscillator type) device that pumps a single-turn loop mounted on the studio wall. The modulation for this transmitter is provided by the signal on the intercom line between cameramen and control. In the event that a stage hand needs to reply to the control room, he merely picks up one of the several house phones located at strategic places in the studio.

Video Control

The video control room houses only the equipment used for control thus resulting in a clean, efficient floor plan (see Fig. 8). The rack equipment associated with video control is located in the projection room and forms a divider between the room and the video shop. (See Fig. 11.)

The single console houses five TM-6 Master Monitors: two for the I.O. cameras; two for the vidicon cameras and one for program preview. Two additional picture monitors, mounted directly in front of the control console, display program-line and network video. These monitors face the ceiling and the video supervisor views them via a suitably mounted mirror, see Fig. 14.

FIG. 15. TV-Audio Control/Announce Booth. Control console is BC-2; 70-D turntable in far corner; BK-1 mike mounted in console. Note two RT-7 Cartridge-Tape Units with recording amplifiers at far right. George Hack awaits a video cue.

Audio Control

WBOC-TV operates with all TV-audio control gear mounted in the announce booth, as shown in Fig. 15. This room, triangular in configuration, faces both the video control room and the studio. The console is a BC-2 specially modified to dual-channel operation with provisions for ten microphone inputs. To simplify cartridge-tape operation, remote-control buttons for the two RT-7 cartridge devices have been added to the console, see Fig. 15.

Recording facilities for the RT-7 cartridge units permit preparation of spot announcements, program themes, etc., in advance of air time thus reducing the tedium of station-break time by releasing the announcer for switching tasks without the pressure of live announcements.

Network Facilities

As mentioned earlier, WBOC-TV broadcasts the programs of each of the three TV nets to the Salisbury area. Programming is obtained by an air pickup of the appropriate station in either Baltimore or Washington at a point some 40 miles southeast of the Baltimore-Washington area, on the east coast of Chesapeake Bay. Here, the demodulated signal modulates a 7 kmc microwave system that, in two hops, terminates at WBOC-TV's transmitter site, almost 50 miles from the pickup site.

The obvious reason for terminating the microwave system at the transmitter site is the usefulness of the antenna tower as a receiving antenna location.

Special switching patches the microwave output directly to transmitter input at the terminal point. The studio controls this switching via a leased d-c line. For network cueing purposes, the station operates its own RG-11U line between studio and transmitter sites.

The program-video line between studio and transmitter is a leased coaxial cable with appropriate equalization equipment, also leased, at both ends.

Educational TV

WBOC-TV turns over its facilities to educational television for two hours every weekday afternoon as a public service. Realizing no profit from this service, WBOC-TV bills the cooperating schools only for out-of-pocket expenses. As of this writing, there are ten cooperating organizations, with more in the offing with the increase in power.

As for the educational programming, the school systems devise and produce the material, using their own instructors and

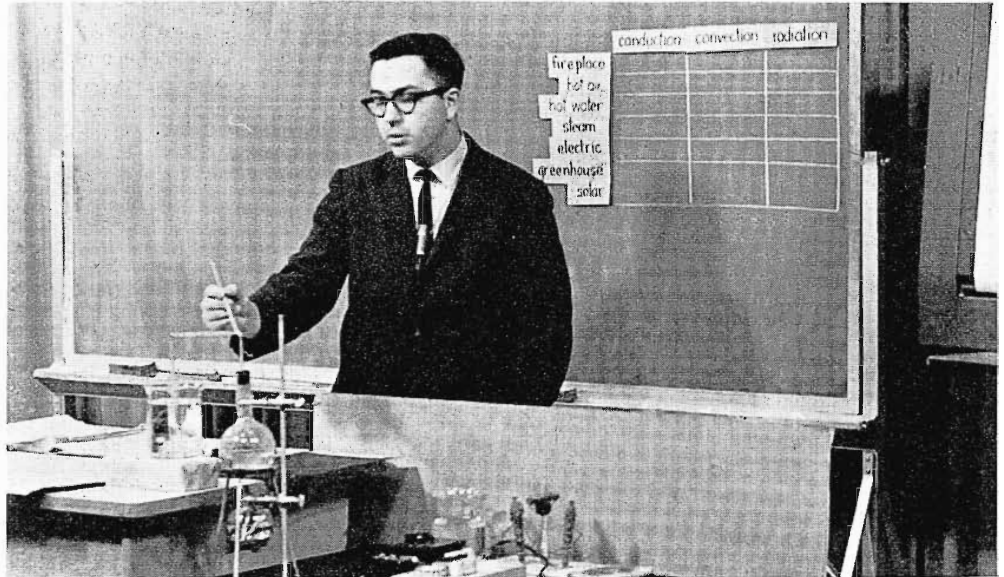

FIG. 16. Instructor James Fox delivers a science lecture on the transfer of heat. This program is part of the daily two-hour ETV schedule.

talent. It is expected that the power increase will enlarge this educational audience considerably. It presently serves 20,000 public school students.

TV Transmitter Facilities

Located on a 20-acre tract a mile north of Radio-TV Park (the studio site) is WBOC-TV's 1800-square-foot transmitter building and the 600-foot tower which supports the UHF-Pylon Antenna.

As Fig. 1 shows, the transmitter building is a roomy, comfortable structure providing excellent access to all equipment elements.

Illustrating the imaginative design that went into the transmitter floor plan, the filterplexer is mounted atop a storage cabinet instead of a table-top installation. This,

of course, makes excellent use of occupied floor space.

Since the transmitter itself serves as a room divider, only the "front" side need be air conditioned for personnel comfort; the rear side is cooled during summer by an attic-type exhaust fan which is thermostatically-controlled. The air inlet for this fan is at the opposite end of the building to provide the most efficient air path along the rear of the transmitter cabinets.

Converting the Transmitter from 1 to 12.5 Kilowatts

The first task, after the planning stages, was the modification of the transmitter plant. The shaded area of Fig. 18 shows the floor plan of the 1-kilowatt plant and illustrates the new floor plan. The only operating equipment that needed to

FIG. 17. Radio-TV Park, Salisbury, Md. The original building, erected during 1940, has experienced no change in silhouette despite three major expansions to include all station facilities except for the TV transmitter.



be moved was the four racks of audio, video and "telco" equipment (lower center of Fig. 18).

The filterplexer had to be replaced owing to the increase in transmitter power, however, the dimensions of the 12.5-kw device very nearly duplicate those of the 1-kw unit thereby eliminating any major mechanical changes to the cabinet that supports it. It was merely a matter of replacement after sign-off time one night. Once installed, the 12.5 'plexer handled the 1-kw transmitter output until the "big" changeover.

Owing to the building-block design of the TTU-12A Amplifiers, they were moved into place during air time without disturbing the operating 1-kw transmitter. With cabinet-to-cabinet wiring preformed at the factory, much installation time was saved in that the crew merely hooked the cabinets together without the time-consuming task of measuring, cutting, stripping and terminal-ing the wires. This is a standard feature of all RCA transmitters.

This wiring and the transmission line installed, the crew installed the heat-exchanger and the plate-power transformers and made the appropriate connections.

It should be pointed out that the TTU-12A Amplifiers are the first UHF equipment in the industry to use silicon rectifiers in place of tube-type rectifiers. This increases the reliability of the system in that the solid-state devices eliminate the idiosyncrasies of vapor rectifiers (arc starvation, temperature sensitivity, arc-back). Further, silicon rectifiers rarely wear out as do tubes, consequently, replacements are rare.

The TTU-12A simplifies maintenance procedures in that the aural and visual amplifiers are essentially identical. This, of course, reduces the investment requirements in spare parts because one inventory serves two amplifiers.

With the visual and aural power amplifiers in place without an interruption in air time, the check-out and testing of the new units was performed after sign-off time.

The last big step was the installation of the new TFU-24DL Pylon antenna which required the removal of the old antenna from the tower top. This task, too, was scheduled during off-air hours but the weather wouldn't cooperate (a 20-knot wind), so the installation was postponed until the next day, a Saturday.

Owing to excellent weather conditions on the afternoon of that Saturday, it was de-

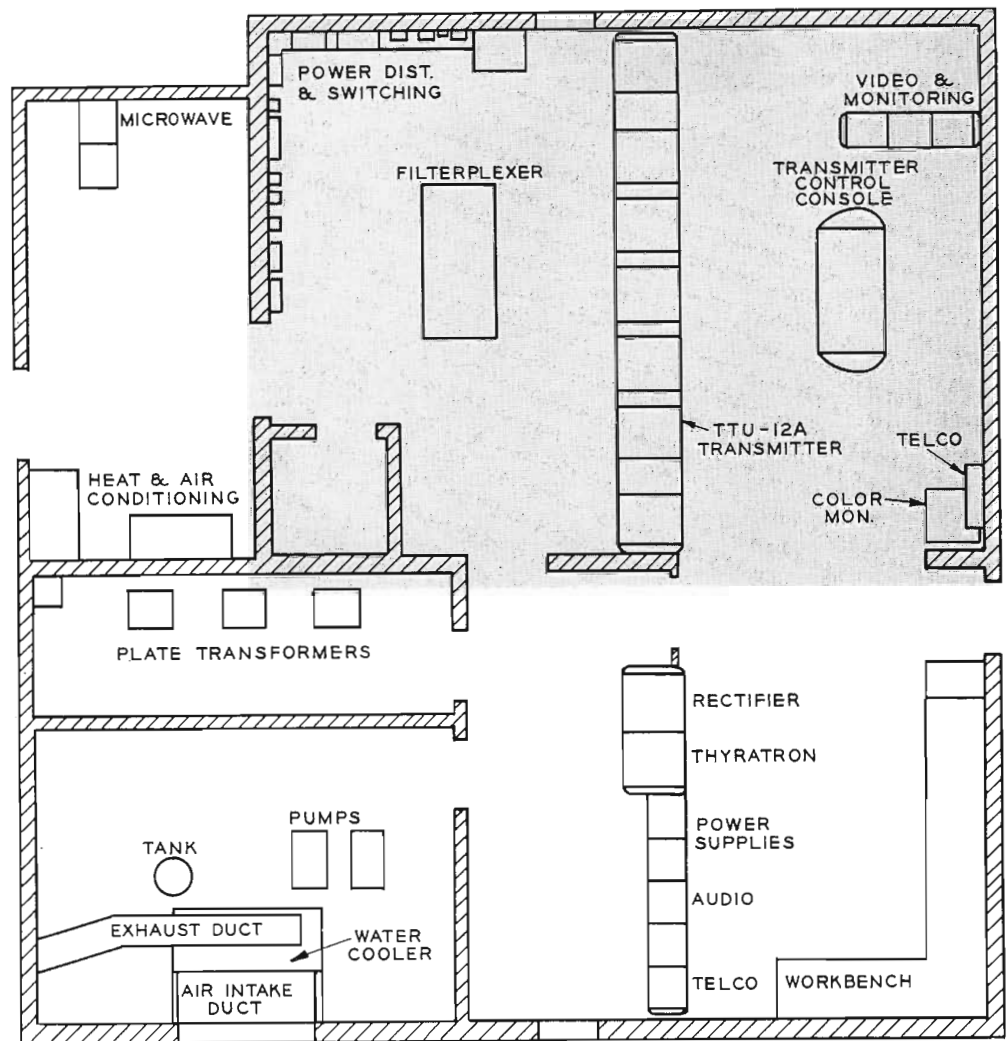

FIG. 18. Simplified floor plan, transmitter building. The shaded area indicates the original size of the building. The center three cabinets in the row (in the shaded area) are those of the original TTU-1B Transmitter. The two groups of cabinets either side of these three are the aural- and visual-power amplifiers and associated controls. (See Fig. 1 for interior view.)

ecided to install the antenna despite the loss in air time (good weather in December is a rarity).

Promptly at 1:30 P.M., WBOC-TV made its final station break at 15 kw ERP and left the air. The crew was already on the tower, making preparations for disconnection of the old antenna and the raising of the gin-pole to the tower top.

In less than 8 hours, the old antenna was on the ground and the new unit in place and tested. WBOC-TV resumed programming at 9:30 P.M. . . . only eight hours after leaving the air . . . with a full 225 kw ERP.

Although formal field-intensity measurements are not completed, many unofficial sources report significantly improved coverage of the essentially flat terrain. The predicted service contours now encompass Dover, Delaware, on the North, the Maryland ocean beaches on the East, Accomack, Virginia, on the South and the Chesapeake Bay on the West.

Growth is Keynote

Ever since those early days of the 250-watter, WBOC personnel have been planning expansion. First it was a move up to a kilowatt of AM power, then television, then 5 kw AM and now, the TV-power increase to 225 kw ERP. Growth is the keynote of the WBOC philosophy.

It's important to point out that the greater part of this almost-continual expansion was planned and executed by the engineering department of WBOC with very little outside help.

Adding the power amplifiers to an existing transmitter as WBOC-TV did, prevented premature obsolescence of their 8-year-old 1-kw equipment and, at the same time, reduced the investment required for the power increase. Further, the installation of the new equipment—owing to its design—was accomplished during program hours while the old transmitter continued to carry programming. Thus, the station suffered no loss in revenue during the expansion.

MILWAUKEE ETV SYSTEM USES BOTH VHF AND UHF CHANNELS

by JAMES C. WULLIMAN
*Assistant Station Manager,
Milwaukee Board of
Vocational and Adult Education*

WMVS, Channel 10, and WMTV, Channel 36, Provide Programs for Grade and Vocational Schools, Technical Institutes and Colleges, Medical Associations and Special Interest Groups in the Surrounding Community.

In January 1963 television viewers in Milwaukee, Wisconsin, found a second educational channel had been added to the list of existing stations. In October, 1957, the city's four commercial outlets were joined by the ETV station, WMVS, Channel 10. Now, its sister-station, WMTV, Channel 36, brings the second ETV station to Milwaukee and the total to six television stations for the city and surrounding area.

Station WMVS, Channel 10, began its operation in 1957 with two and one-half hours of programming per day. At that time it operated on 129 kilowatts, however, in 1960 it went to full power (316 kilowatts). With 40 per cent of the population in Wisconsin residing in Channel 10's nine-county coverage area, the demands on the

BENEFITS TO MILWAUKEE SCHOOLS FROM USE OF ETV

Milwaukee Public Schools, and Catholic Archdiocese Schools have noted the following benefits from using television in the classrooms:

1. General upgrading of teaching at all levels
2. In-service benefit to teachers using programs
3. Economy in use of school classrooms which otherwise not used:
 - a. Cafeterias, b. Auditoriums, c. Gymnasiums, d. Multiple purpose rooms
4. Providing instruction where otherwise it would not have been possible
5. Made possible introducing new curriculum
6. Made possible (in case of Catholic Schools) for teacher to reach out to schools in Archdiocese she never could have reached prior to TV
7. Economy in use of teachers

Generally, TV in Milwaukee is providing similar results and benefits to those found in other areas where it is being used in the classroom. It has been effective in the areas indicated for the Milwaukee Public Schools, and the Parochial Schools.

The Milwaukee Institute of Technology of the Milwaukee Vocational & Adult Schools is using television in teaching several of its core courses. The primary benefits from this are:

1. Economy of classroom space. This is large group instruction, and where several sections met previously in a number of rooms, one large room suffices.
2. Savings in the number of teachers required to teach the core courses. This frees teachers to develop and teach new courses.
3. Unity in teaching for all members of student body taking core courses. TV teacher provides basic lecture, small group of instructors the discussion and follow up work.
4. Improvement in quality of teaching:
 - a. In-service benefit, b. Team teaching benefit, c. Increased use of visuals.



FIG. 1. All floor crew work is handled by members of the two-year telecasting course offered by Mil. Inst. of Tech. division of Milwaukee Vocational and Adult Schools. Each student is assigned to a studio workshop, fitted into his class schedule. Students participate in on-air and closed-circuit assignments.



FIG. 2. Pictured at RCA TV Tape Recording equipment are Otto Schlaak, Stations Manager; Dr. George A. Perkinson, Director, Milwaukee Vocational and Adult Schools; and James C. Wulliman, Assistant Stations Manager in Charge of Operations.

FIG. 3A. Milwaukee Institute of Technology, which houses Channel 10's "Studio C."



station's program hours have been steadily growing. It is currently on the air from 8:00 a.m. to 10:30 p.m. daily, Monday through Friday. Weekend programming has not been possible because the station functions within the normal school-week and uses student crews.

From 8:00 in the morning until 2:30 in the afternoon the station programs primarily for in-school viewing. Both the Milwaukee Public Schools and Milwaukee Catholic Schools use the station facilities for instruction. From 2:30 in the afternoon until 10:30 in the evening Channel 10 serves the community in various ways.

The station is licensed to the Milwaukee Board of Vocational and Adult Education. The C.P. for WMVS, Channel 10, was granted to the Board in June, 1956. The station's on-air date was October 28, 1957. Channel 36 was granted its C.P. in February, 1962. Construction was completed in November, 1962. Both WMVS and WMVT are affiliates of the National Educational Television and Radio Center network.

Director of the Milwaukee Vocational and Adult Schools, Dr. George A. Parkin-

son, is Executive Director of the stations. Station Manager is Dr. Otto F. Schlaak; and James C. Wulliman is Assistant Station Manager in charge of Operations, and Chief Engineer. Guy G. Morrison is Assistant Chief Engineer; and Harold G. Wagner is Transmitter Supervisor.

Historically, the Milwaukee Vocational and Adult Schools was one of the first applicants for an educational television license after the FCC freeze was lifted in 1952, but construction was delayed until 1956 by extenuating circumstances.

Proposals were made originally to locate the transmitter on the roof of the Milwaukee Schools building. An offer from former station WITI-TV owners to locate on their tower with a 20-year lease (terms, one dollar) caused a change in plans. Channel 10 built its own transmitter building on the tower site and operated there until 1962, when Storer Broadcasting Company (new owners of WITI-TV) moved to new quarters and provided space for the ETV transmitter in their building on Capitol Drive in the city of Milwaukee. Their new tower, considered to be America's tallest

self-supporting tower, now supports both ETV antennas (VHF and UHF).

Production and Programming Facilities

These were provided on the sixth floor of the MVAS building, in the downtown area of Milwaukee, just at the edge of the Civic Center. This site was selected for integration with the parent school. Channel 10 provides the two-year telecasting course of the school with practical training in on-the-air operation.

Graduates of the two-year course can elect to take the course for Junior College credit in the Milwaukee Institute of Technology, division of MVAS. Graduates receive an Associate Degree in Applied Science. With two additional years at a four-year college or university, students can acquire a B.A. or B.S. (4 year) degree. Many TV graduates have transferred upon completion of the two-year course to the University of Wisconsin-Milwaukee, or Marquette University to secure their four-year degree. Graduates of the M.I.T. television course are now working in television stations throughout Wisconsin and other parts of the country.

FIG. 3B. Milwaukee Vocational and Adult Schools. To the right is second floor overpass leading to the Tech building (Fig. 3A). The five divisions of the Vocational School last year had over 30,000 students enrolled in various courses.





FIG. 4. This teenage quiz show produced by the Milwaukee Public Museum and presented weekly on Channel 10 offers a real challenge to the high school panel members. Object of the game is to correctly identify unusual museum specimens for host, Leon Weissgerber of the Museum staff.



FIG. 5. A special Christmas program, complete with Golden Age chorus, presented from Studio "C". Approximately 350 viewers crowded into the auditorium for this special program. GOLDEN YEARS is broadcast weekly on Channel 10.

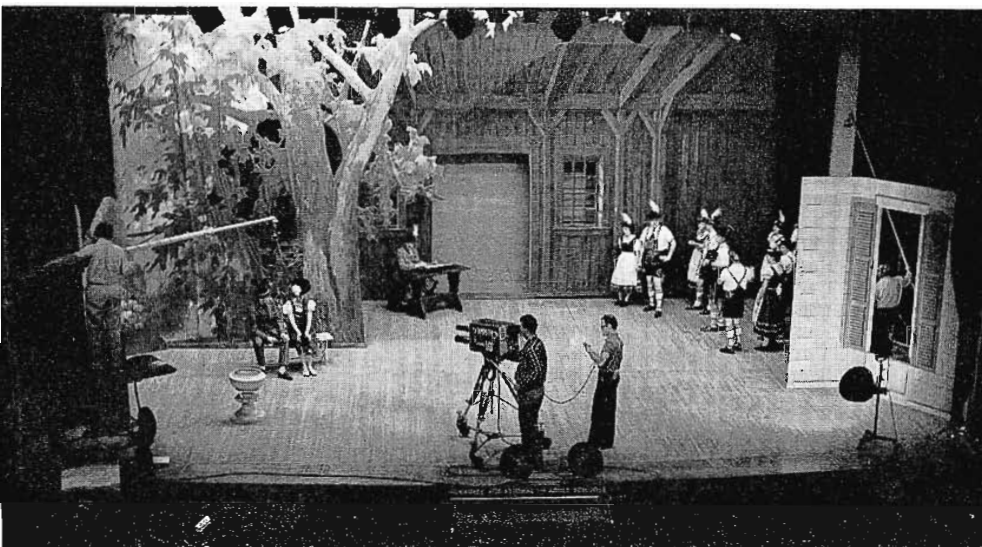

FIG. 6. "Viennese Springtime," an hour long production based on the story of Elizabeth, Empress of Austria was televised in Studio "D". Seventy-five dancers from the International Institute participated, along with a soloist from Milwaukee's Florentine Opera Company. Members of little theater groups in the city played the lead roles in this dramatization.

Studio Facilities

Four studios are available to the stations for broadcasts. Studios A and B are located near the production offices on the sixth floor. Cooley Auditorium (Studio D) on the second floor seats 1900 people, and is used for orchestra and band concerts, dramatic productions (since they have theatrical lighting and stage drops). The auditorium also has a pipe organ which has been used in several television series.

The Milwaukee Institute of Technology, which is a division of the MVAS, has a newer building across the street. The two buildings are connected by a second floor overpass and an underground tunnel. In the new building, the auditorium (Studio C) is designed for television as well as for classroom use. It has a 20-foot turntable on the stage, 420 tiered upholstered seats for studio audience, television control room at the top of the auditorium, theatrical dimmer controlled lighting, cyclorama and overhead lighting grid, an overhead door large enough to permit small airplanes, cars and trucks to be brought into the studio. There are also cloakroom facilities at the entrance to the auditorium.

Studio C has its own permanent equipment, including two TV cameras. A third camera is brought in when needed. Studio C control room is connected to master control in the old building by coaxial cable and audio lines. Studio D has its own control room facilities and equipment, but cameras are brought in for each show.

Studio A

Studio A is 27 by 55 feet, with a 14-foot ceiling. (This should be higher but structural changes would have had to be made to the building.) The lighting grid is 12 feet high, mounted on concrete beams. Walls are covered with two-inch thick Johns Manville MK blanket with a muslin surface.

Lighting arrangement is provided by a pipe grid on 5-foot centers, with connector strips across the studio. Total pigtail outlets number 48. All are on 20-amp circuit breakers. There are no dimmers. General level of illumination averages 100 to 120 foot candles.

Studio "A" air-conditioning has a ten-ton capacity. All studios and control rooms are air-conditioned, along with film and projection rooms.

Normally, there are two TV cameras in Studio "A", one on a large pedestal, one on a tripod, however, the studio is equipped with cables for three cameras. There are outlets for 12 microphones, and also rear projection facilities in this studio.



FIG. 7. View of Studio "A" showing lighting grid, rear screen and other equipment.

Studio A is used for CHILDREN'S FAIR, a daily half-hour children's program originated by the station. Talent for this program is drawn from both the staff and outside the station. All talent is contributed and staff members involved all have other full-time duties, ranging from that of staff artist, producer-director, film supervisor, to station manager. Outside talent donates services, too. Interview programs, small dramatic productions such as WAY OFF BROADWAY, music programs involving the use of a piano, small chamber groups, in-school broadcasts on science, history, physical education, art and speech are also done from this studio (or studio "B").

Control room A is located in a small room off the end of the studio. It has a slightly elevated floor level for audio board and switcher. The director is on a higher level which overlooks engineers and monitors into the studio. The lower level has two engineers for a show, one on audio, one for switching. The latter functions as technical director and is also responsible for lighting with the aid of the student crew.

Control A can handle a complicated program using both A and B studios since B cameras also appear on A switcher. Frequently, square dancers or ballet dancers appear in Studio B while Studio A is used

FIG. 9. Studio "B" showing announce booth (upper-left) and position of control room "B" directly above observation room at rear. Director is Bruce Fowler. Manning cameras and floor-directing are members of the television course. The announcer is also a student.



FIG. 8. Control Room "A" shows director, Rod Thole in upper-right corner; with switcher, George Wojak; and audio-man Tom Heinze.



for dramatic vignettes, for narration, and for music portions of a show.

Studio B

Studio B has the same lighting facilities and general construction as Studio A. Dimensions are 27 by 45 feet. There are outlets for 12 microphones, and two TV cameras, one on a lightweight pedestal and the other on a tripod. Cable is provided for a third camera. This studio also has a rear projection screen.

Control room B is located at the end of the studio—not a separate room—but was a balcony of the original classroom. It is now enclosed . . . has an announce booth, an observation room below, and can be handled by a two or three-man production



FIG. 10. Control Room "B". Director is C. H. Logan; switcher, Guy Morrison; and audio-man, Martin Wilke.

staff, depending on the type of program. The director in this control room switches routine programs. Intercom facilities are the same as those in A control. Both A and B are equipped with cartridge and audiotape recorders for themes and announcements, and there are two turntables in each control room.

Each studio has its own announce booth, and there is also an announce booth for master control. This booth has a large window in it which can be used for simple, announcer-on-camera programs. The booth is located next to Studio A and looks into it.

The observation booth under "B" control is the only area where visitors can observe live programs. It holds, comfortably, about fifteen people and is inadequate. When live shows such as TOWN HALL are done, requiring seats for 300 or more people, it is then necessary to use Studio C, or Cooley Auditorium (Studio D). When NBC correspondent for the United Nations, Pauline Frederick, was here for TOWN HALL the night the President announced the blockade of Cuba, Studio C accommodated almost 400 people.



FIG. 11. Projection room, showing three film islands. On 3 monitors in background can be seen Channel 10 and Channel 36 I.D.'s. Film-man John Boeticher loads a slide projector.

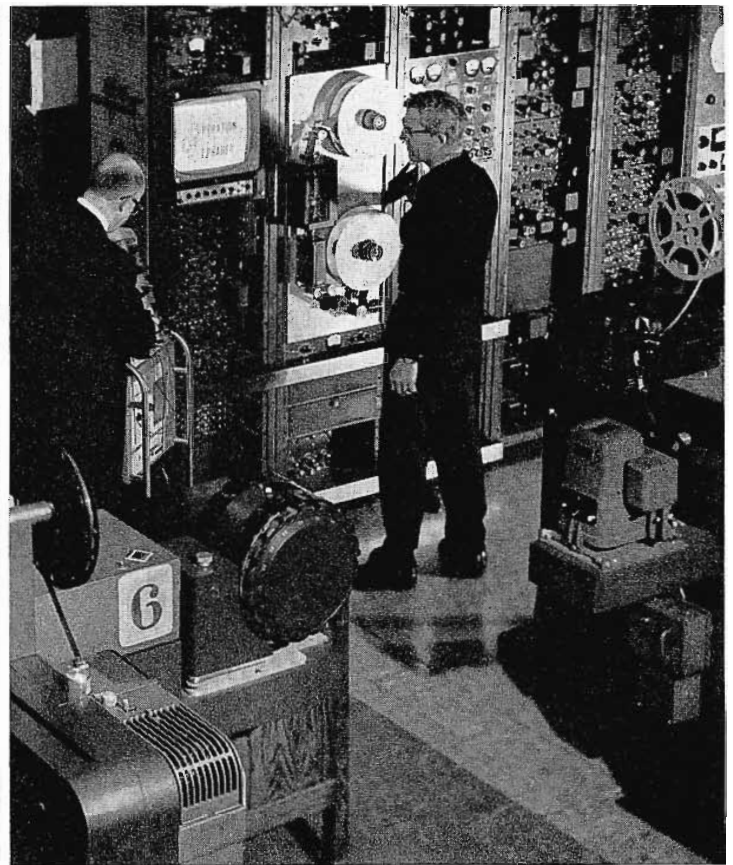

FIG. 12. Chief engineer, James Wulliman, and asst. chief engr. Guy Morrison check out TV tape recorder in projection room.

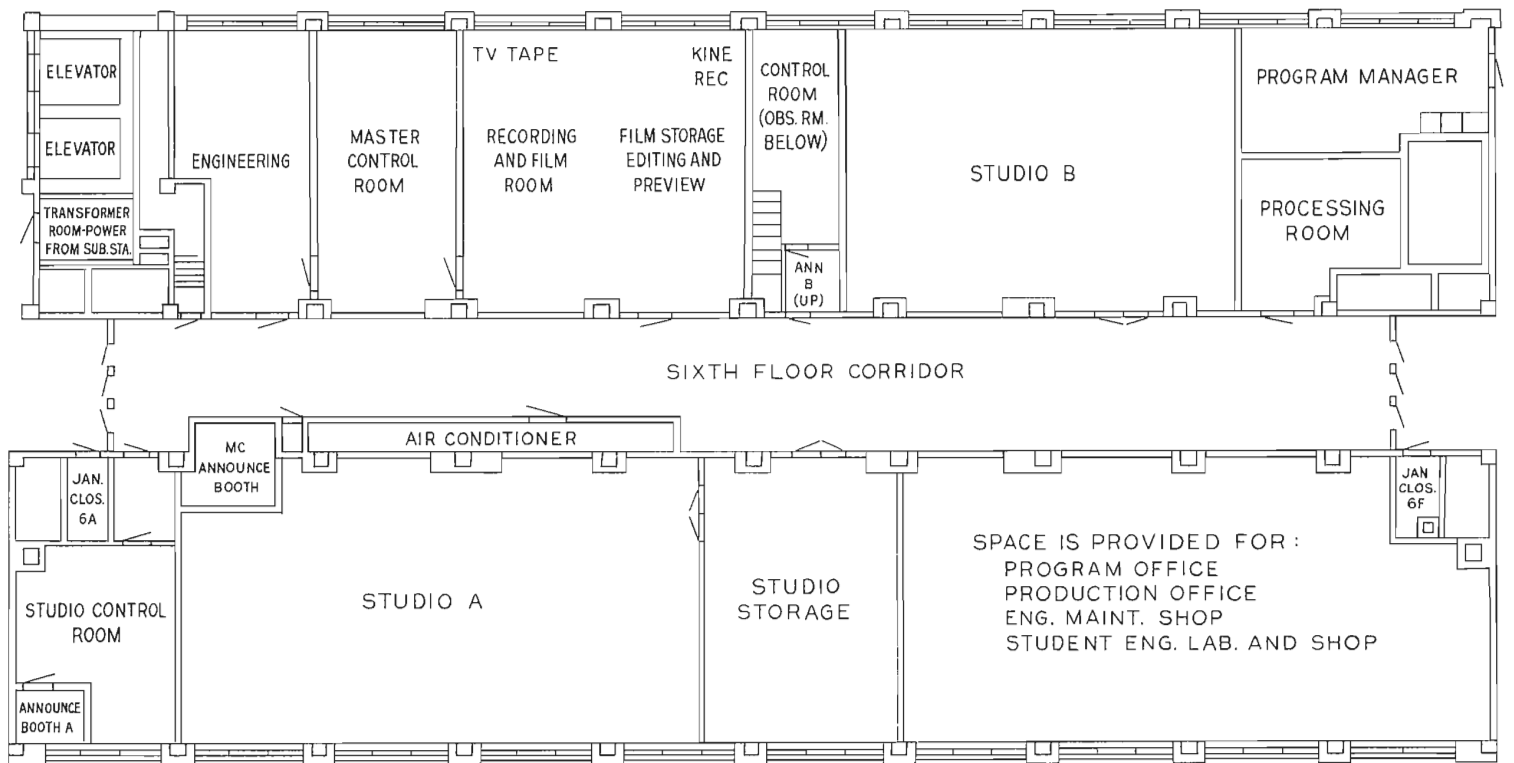

FIG. 13. Layout of ETV studio system.

FIG. 14. Master Control. WMVS's one-man operation required greater consolidation of equipment than was possible with a long console arrangement, so it was recently changed to this rack-mount for the operating position.

Film Facilities

The film projection room is located between master control and Studio "B". Editing is done in the same room. A dark room is located near Studio B next to the Film Supervisor's office. Storage facilities are across the hall from the projection room.

Projection equipment includes: three vidicon film chains, three 2 x 2 slide projectors, five 16mm motion picture projectors, and one 3 x 4 balopticon for opaques, crawls, etc. Two TV tape recorders, and a kinescope recorder are also located in the projection room.

The station has three TV tape recorders . . . a Type 1000B and a Type TRT-1B are located in the film projection room. A compact TV recorder, Type TR-11, is located in the mobile unit.

Film control is located in master control . . . all film and tape is remote controlled from master control except during live programs requiring constant attention of projectionist.

Among film equipment used in the station there are: four 16mm movie cameras, a still camera, and a 16mm film processor as well as complete copying and darkroom facilities.



Master Control

In master control the console was recently changed to a rack-mount for the operating position. WMVS one-man operation requires greater consolidation of equipment than was possible with a long console arrangement. All power supplies, distribution amplifiers and relay banks are in the same room. The master program switching system is a pre-set relay type. An operator can pre-set all functions, both audio and video, from eight sources to six outputs and transfer with a single button. The outputs are: WMVS (STL); WMVT

(STL); Network; VTR-1; VTR-2; Moni-tran (House Monitor System).

The rack-mounted equipment at the operator position was installed after much investigation of possible arrangements for a control center. All live camera controls, film camera controls, tape and film remote controls are located in master control. The one-man operation uses cartridge audio tape for announcers.

Transmitting Equipment

Transmitters for Channel 10 and Channel 36 are located at 1100 East Capitol Drive, near Lake Michigan, on the corner

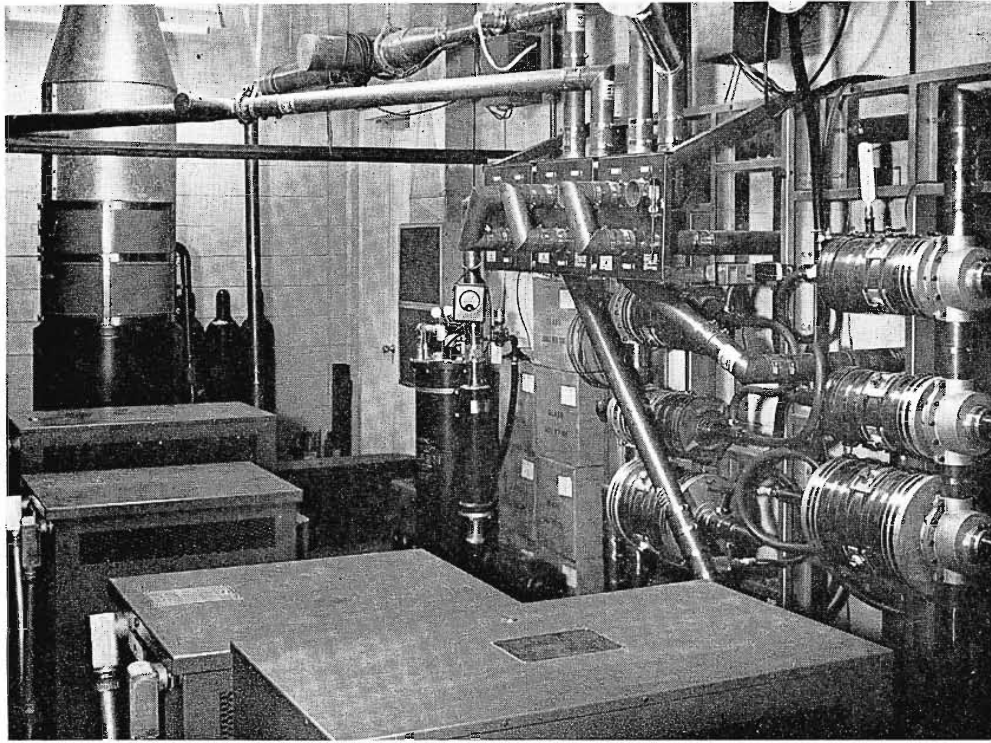

FIG. 15. Coaxial transfer panel at rear of channel 10's transmitter.

of Estabrook Park in the village of Shorewood (adjacent to Milwaukee). Space for this equipment was provided by WITI-TV (Storer Broadcasting Company). This new location near the commercial television stations was chosen for the "antenna farm" concept, which minimizes air hazards and provides optimum antenna orientation. The transmitter site is approximately four miles from the studios.

Transmitter equipment was arranged by Harold Wagner, Transmitter Supervisor, for greatest efficiency in allotted space. (See floor plan of one-floor building.)

The operating console includes a film chain, a small audio-board and video switcher with connections for mobile TV tape recorder. This unit is parked outside to allow operation in case of failure of either studio or microwave STL system.

A coaxial patch system provides for power cut-back in emergency and for testing. The grounding system is heavy copper strap in trench tied to WITI-TV and Power Company ground.

Channel 10 is already on full power (316 kw) and provision has been made to increase Channel 36 UHF power when funds are available. Channel 36 is now operating at 30 kilowatts E.R.P. over the land area.

The antennas of both stations are side-mounted on the northwest leg of the 1078-foot self-supporting tower (largest in the U.S.A.). Channel 10 antenna is mounted between 741 and 831 foot levels on the tower (750 feet above average terrain). Channel 36 antenna is mounted between

451 and 494 foot levels (440 feet above average terrain). The UHF is a directional antenna with a modified skull pattern oriented to radiate maximum signal over the land area with null area toward Lake Michigan. This takes the power that would be wasted over Lake Michigan and adds to the power over the populated area. The antenna is mounted on a special bracket, six feet out from the leg of the tower to minimize effect of tower steel.

Mobile TV Tape

A custom built mobile unit, was purchased from WWJ-TV in Detroit. It was remodeled by the Schools' engineers with the aid of the auto body shop. Installed in the truck is one of the first TR-11 compact TV tape recorders, cut down to short racks by the Schools' engineers.

Most remotes can be done on a tape delay basis since the stations do not carry news remotes. When live remotes are necessary (for example, during a Medical Society Meeting, or the American Vocational Association Convention which met in Milwaukee the first week in December) relay feed is used to studios. The TV tape mobile unit can be used all over the coverage area and has been effectively used as far as Racine, Wisconsin. Programs from there have been used for regional and national distribution through NET (National Educational Television) network.

FIG. 16. UHF Television Transmitter, type TTU-1B. Transmitter supervisor, Harold Wagner is at operating console.

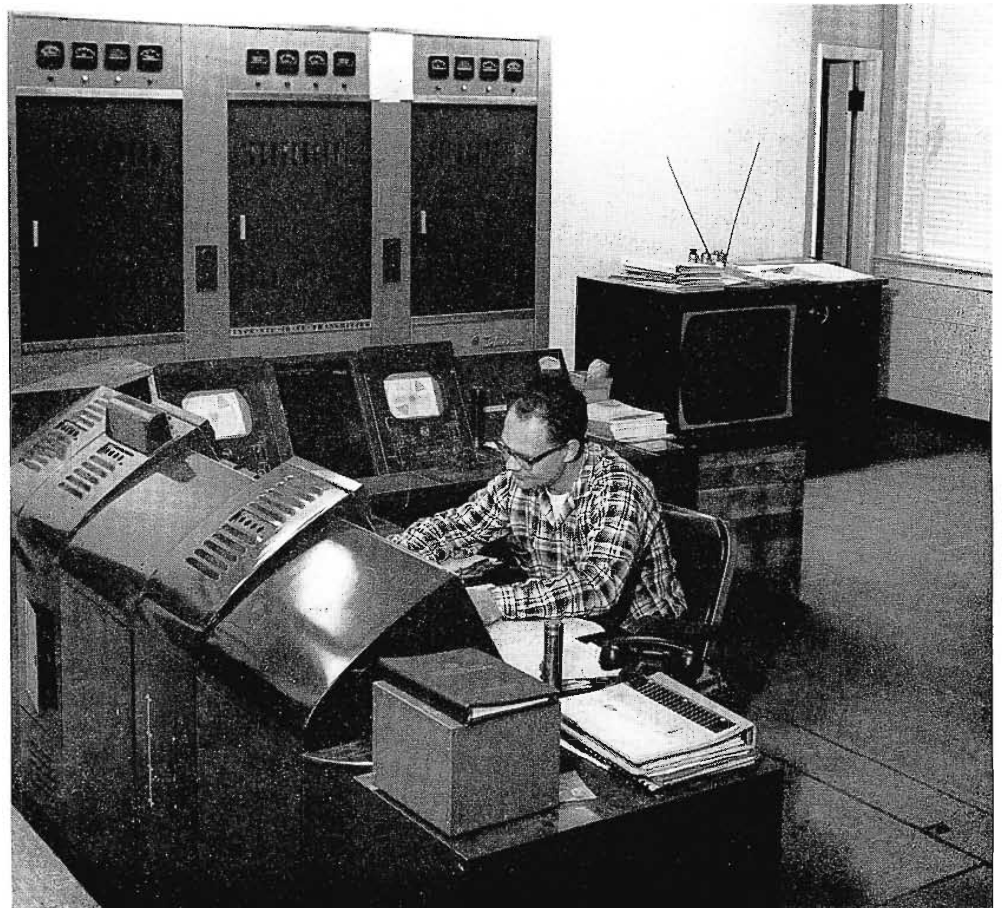

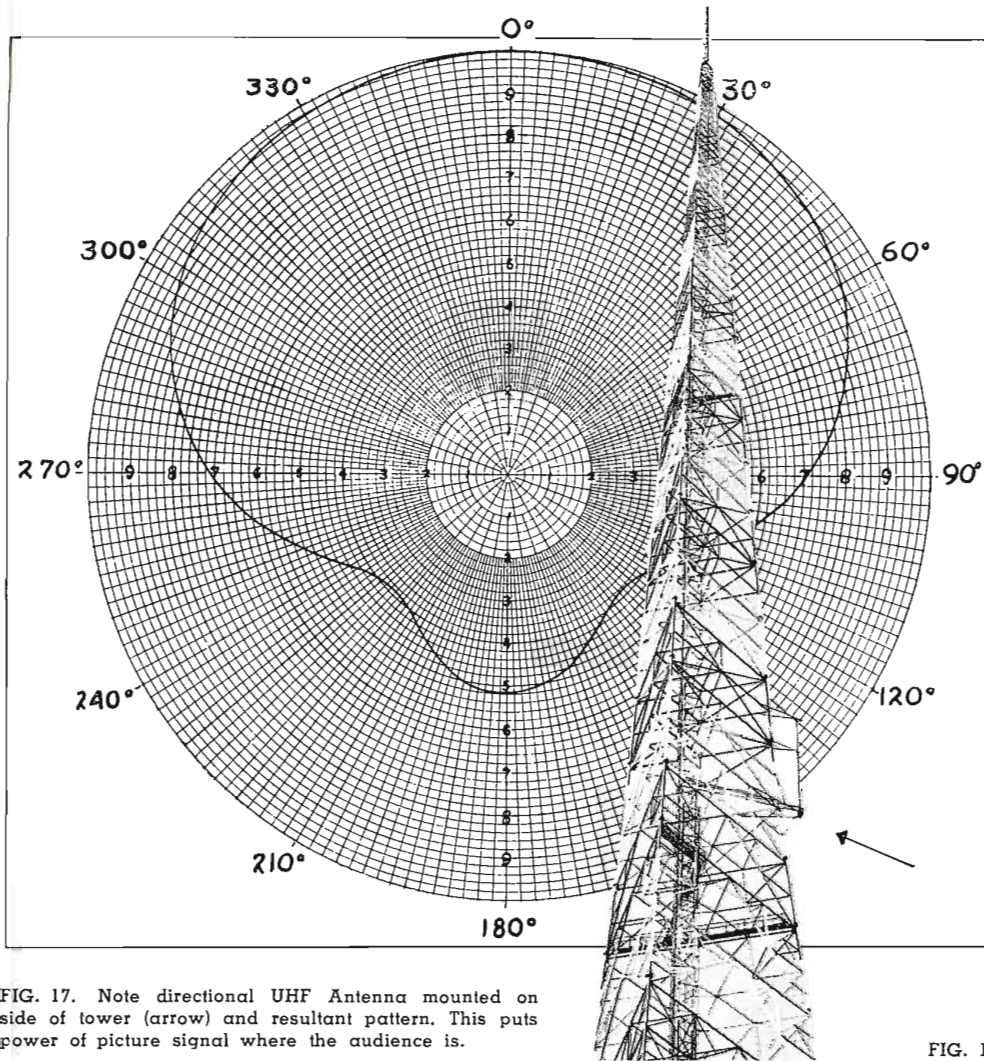

FIG. 17. Note directional UHF Antenna mounted on side of tower (arrow) and resultant pattern. This puts power of picture signal where the audience is.

Microwave System

With the expansion to the second television program service and the second transmitter, it was necessary to install a two channel microwave system to feed the additional program from the studios to the transmitter. During the 1962 summer period, the VHF transmitter had been moved to the new antenna location and it was decided to diplex the two microwave signals. With the new installation, it was apparent there would be a critical angle at which the reflectors would have to be set. To find the critical angles, a scale model of the towers and buildings were set up and the correct angles were found by using a light beam. On setting the angles of reflectors, the signal was found to be more than adequate and the extra attenuation in the diplexer was of no consequence.

Color TV

The stations have planned ahead for color. Studio and master switchers, microwave (STL) and transmitters can be used for color telecasts. FCC color proof of performance tests were made on both transmitters (VHF and UHF) during equipment tests at the new location. The stations can carry network color but can only originate color bars and synthesized color from a monochrome film chain. Future film and live color development will depend on requirements of education for color.

FIG. 18. Remote truck at Wisconsin State Fair park, with members of U.S. Navy Scuba diving team. During Fair week, Channel 10 telecast daily from the Fair grounds.



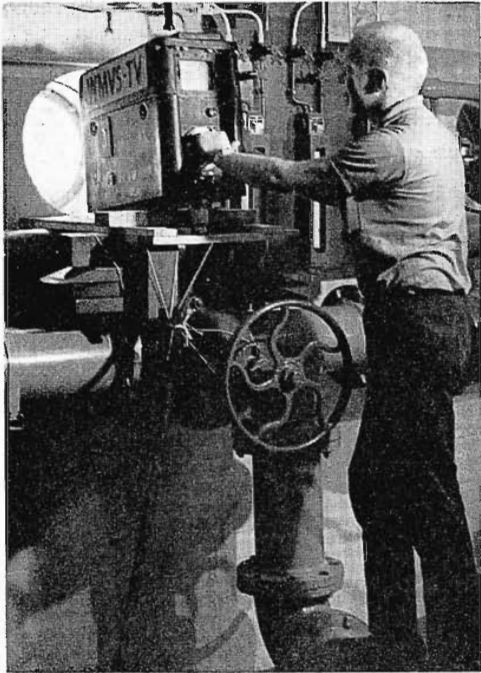

FIG. 19. A remote featuring FROGMEN FIRE FIGHTERS found Channel 10 cameras shooting through underwater portholes at Jackson Park Pool in Milwaukee. Cameraman is Bruce Fowler.

Future Expansion

Designs for new studios and offices are being laid out on the top floor of a new Milwaukee Vocational and Adult Schools multipurpose building. Work on this building is to start in 1964, and be finished in 1965. Expansion of programming is being planned through between-station exchange of programs by TV tape, and then by interconnection within the state and in the midwest area.

The long range plan for Channel 36, WMVT, is to use it almost exclusively as an instructional television station to carry college courses, specialized training courses, and in-school broadcasts. It is planned that the station will provide program time for:

1. Universities and colleges in the area for direct and major resource instruction to adult students, both in and outside the formal school situation.
2. Technical Institutes, Vocational Schools, and two-year colleges in the area at the direct and major resource level, for upgrading and retraining

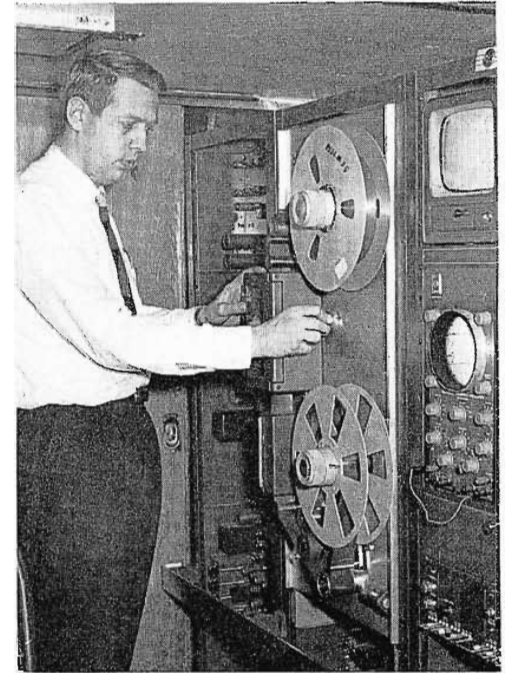

FIG. 20. Engineer Tom Brask, remote supervisor at TR-11 TV tape recorder in mobile unit. Station engineers installed the TR-11 in short racks to fit the truck.

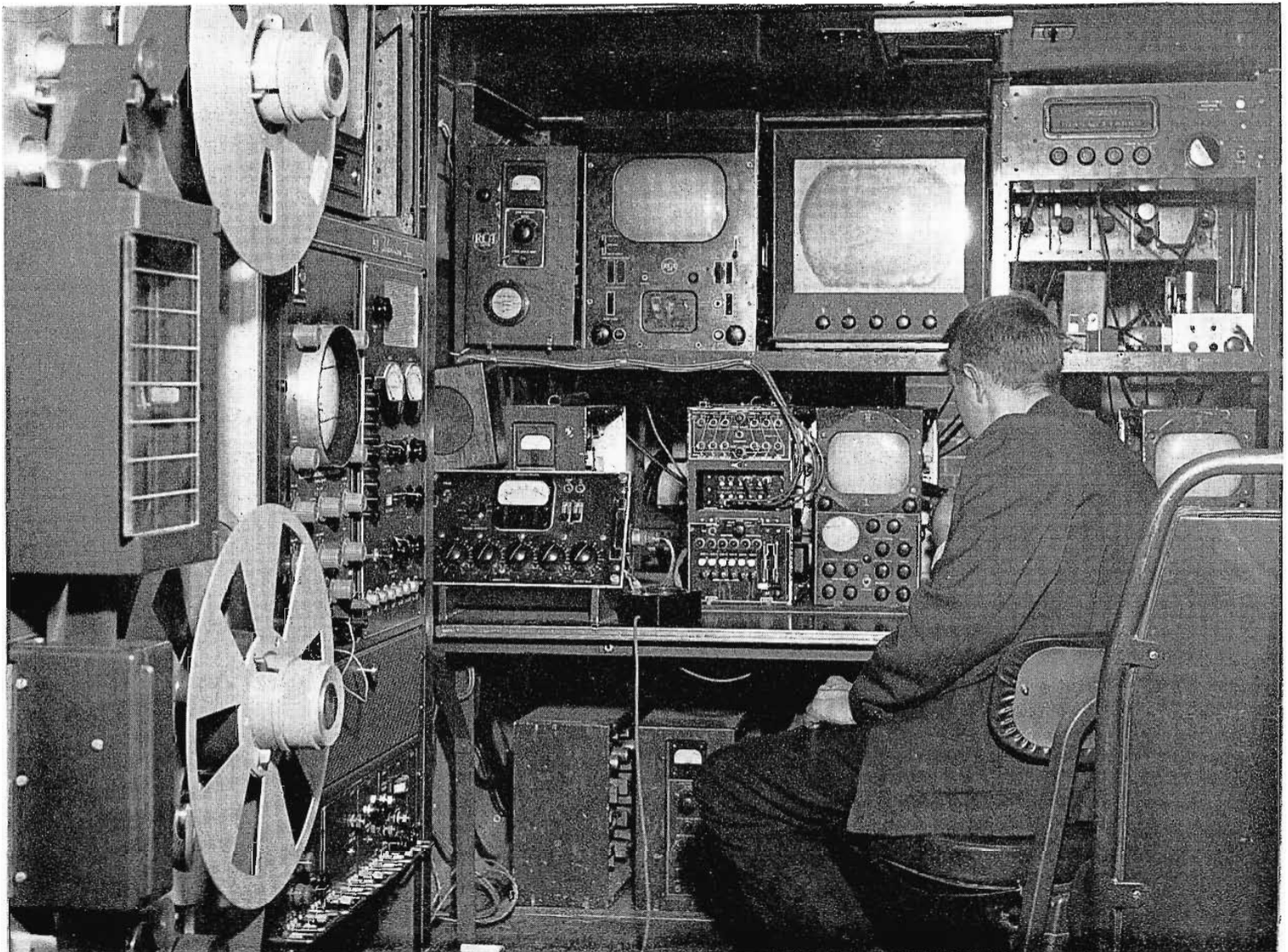

FIG. 21. Interior view of mobile unit shows operating console. WMVS engineers remodeled truck with aid of Milwaukee Vocational Schools auto body shop.

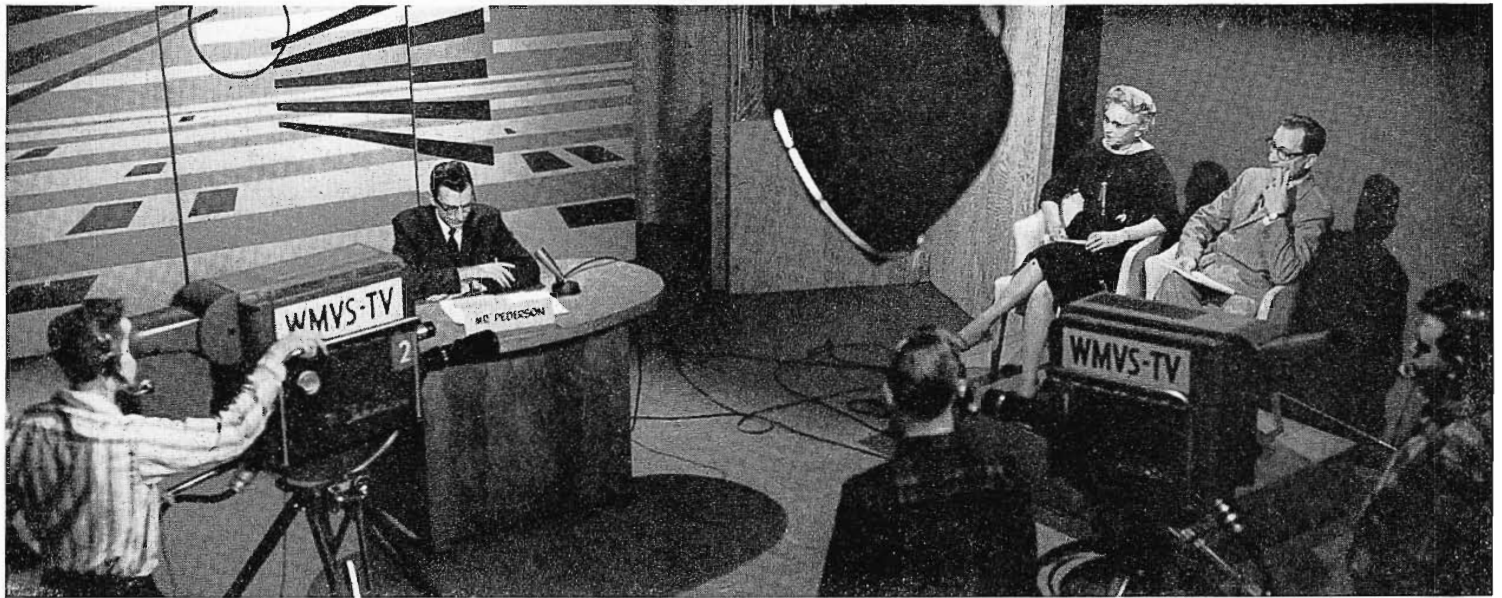

FIG. 22. Milwaukee Public School Board reports to the city via TV monthly. This half-hour public-service broadcast comes from Studio "A".

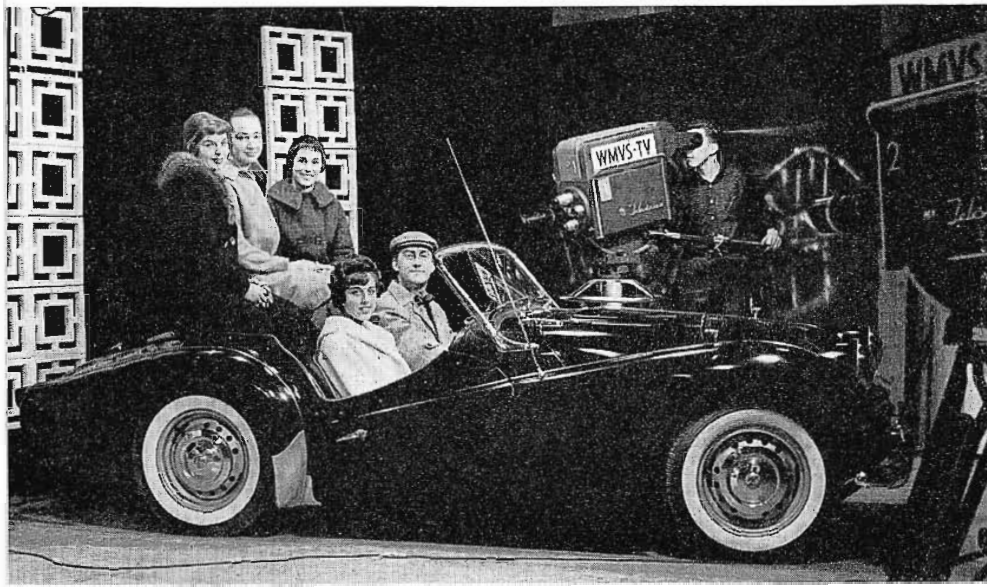

FIG. 23. Teen-age guests on BEST FOOT FORWARD series produced last year by the Homemaking Division of Milwaukee Vocational and Adult Schools.

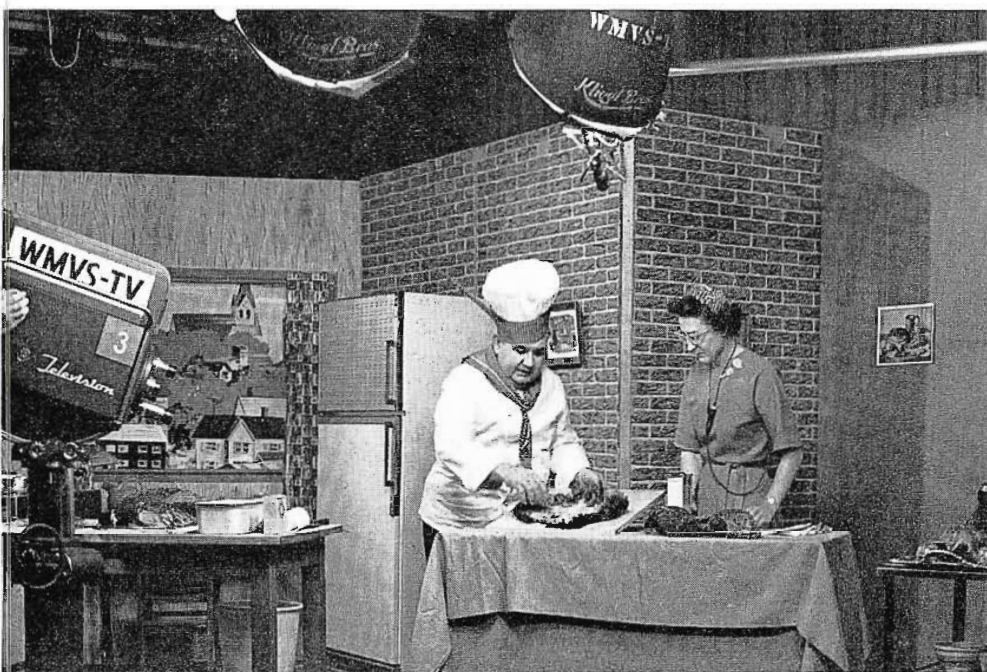

FIG. 24. GOURMET TEN, a cooking series designed for the man in the family, tells how to handle, prepare and cook game from the time of the kill to the pot or pan. Guests are well-known chefs and sportsmen from the area. Helen Brazner, from Homemaking division of Milwaukee Schools produced and hosted this series.

industrial workers and business people in the area.

3. Public and parochial schools in the coverage area for supplementary instruction at all grade levels, adding needed multiple channel availability to these organizations in conjunction with Channel 10.
4. Medical associations and special interest groups requiring instructional television programs with limited appeal, for highly specialized groups.

Channel 10, WMVS, the VHF station with wider area coverage, will continue to do classroom broadcasting; largely programs used by public or parochial schools where a large geographical coverage area is required. Emphasis for the VHF station's programming will be on general adult programs, special programs for teenage groups, young children, and cultural programs, with an alternate programming concept in the program areas of community, state, national and international affairs.

In combination, the two stations, WMVS and WMVT, provide a flexible, well-rounded program facility for the broadest, and most specialized kind of ETV service to Milwaukee and the surrounding community.

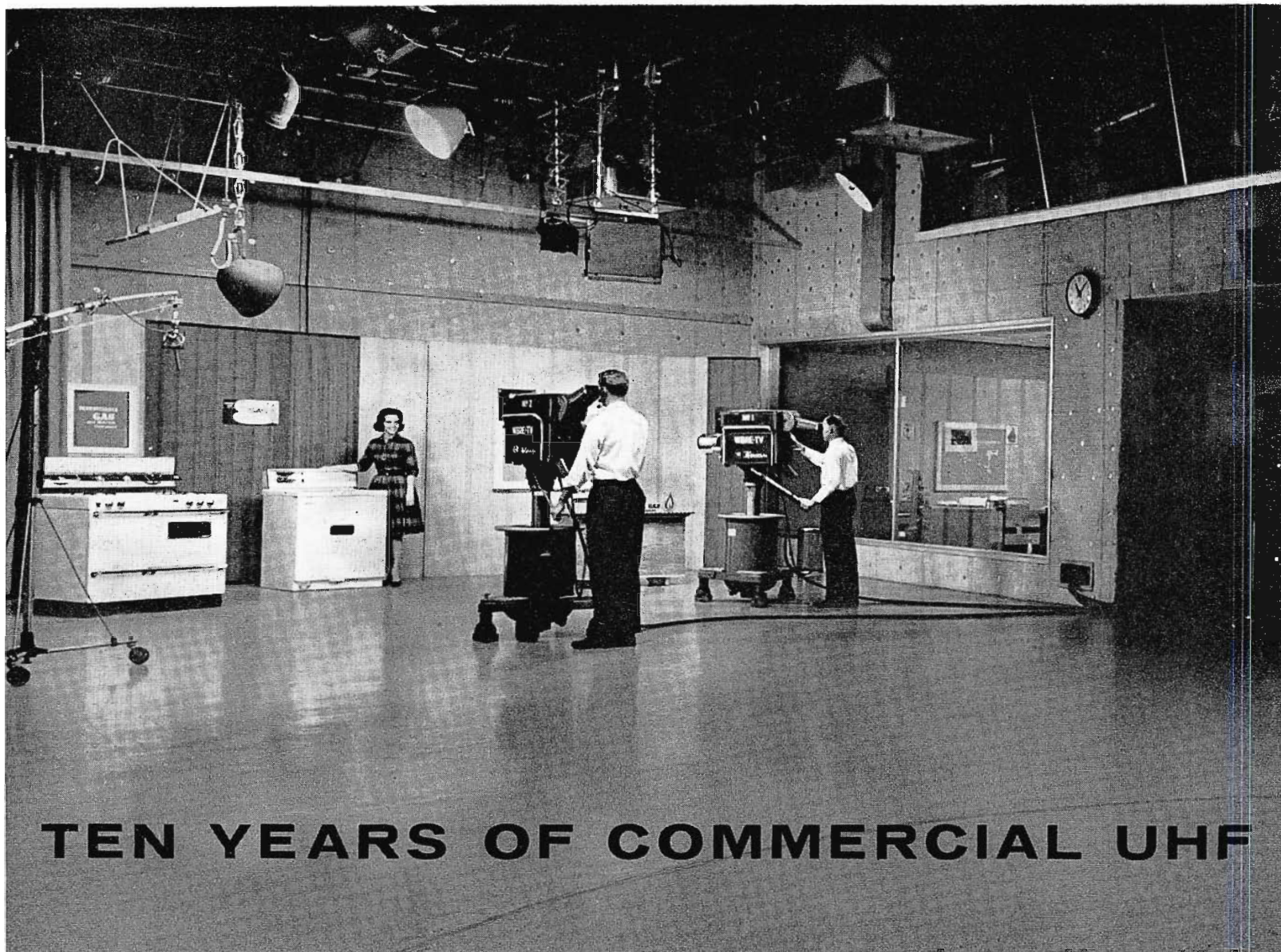

TEN YEARS OF COMMERCIAL UHF

Newest in Facilities
and Color Equipment,
Mark a Decade of
UHF TV Service to
Northeast Pennsylvania

With the coming of the new year WBRE-TV, Wilkes Barre, Pa., celebrated its tenth anniversary of UHF telecasting. A true pioneer, the station began commercial operation on New Years Day, 1953, using the first commercial TTU-1B 1-kw UHF transmitter and UHF pylon antenna. At that time the transmitter-antenna combination provided 17,000 watts ERP, a far cry from today's one million watts emanating from the station's TTU-25B transmitter and ultra-gain pylon atop Wyoming Mountain.

Move to Super Power

Installation of this first RCA UHF transmitter keyed an impressive list of "firsts" in which WBRE-TV systematically updated equipment and facilities. The plan for UHF television was well formulated under direction of Louis G. Baltimore, president; David G. Baltimore, vice presi-

dent and general manager; and Charles Sakoski, Sr., chief engineer. Each step of the plan was carefully executed with the guidance and assistance of RCA engineers.

Initially the plan concentrated on increasing the power of transmitter facilities. To the original TTU-1B transmitter, the station added successive 12½ kw and 25 kw amplifiers—each the first of their kind. The original UHF antenna was replaced with the first ultra-gain pylon. On another New Years Day in 1955, WBRE-TV became the first tv station to operate with one-million watts effective radiated power.

New Studios

With the transmitter program completed, the station turned to revitalizing studio facilities. Originally, studios were located in a converted mansion in down-town Wilkes Barre. As requirements grew, it was decided

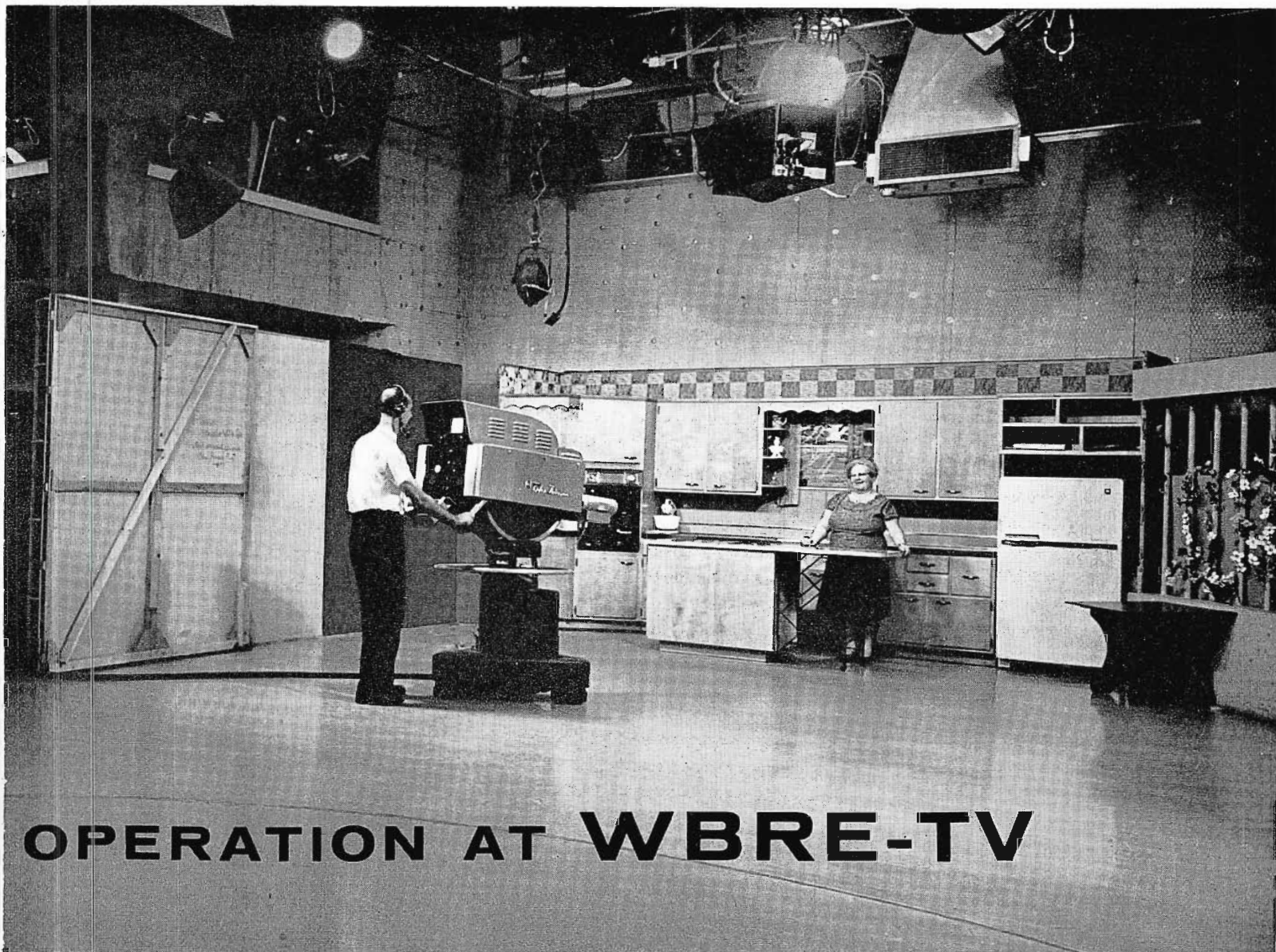

OPERATION AT WBRE-TV

to incorporate studio and control areas in a newly constructed addition at the rear of the existing building. Once completed, the office and administrative areas could be refurbished and modernized.

Because of the emphasis on local public service programming, the studio plan called for a single large studio with 3,000 square feet of floor space. Here groups of 300 or more could participate in programs such as local United Fund dinners and the like.

The design philosophy accents production efficiency. The spacious quarters permit many program sets to be left standing, thereby saving time and labor in the production of regularly scheduled local programs. A huge turntable, accommodating as many as four automobiles is also included in the studio design—as well as permanent facilities for rear screen projection.

Modern Master Control

The production efficiency philosophy carries through into the control room, which combines both studio and master control functions with facilities for producing both tape and film programs. Here equipment is grouped in a single large area and arranged so that operators on duty can perform their tasks with utmost efficiency.

Equipment "Firsts"

WBRE-TV has one of the most modern of layouts and operates some of the newest television equipments. Many of these are the first of their type to be installed by a television station. RCA's first television automation "station-break" equipment was put into operation by WBRE-TV shortly after the 1958 NAB convention. UHF transmitting facilities—in the station's move to one million watts erp—were among

FIG. 1. Equipped for color and monochrome operations, the WBRE-TV studio typifies the modern facilities of this 10-year UHF pioneer. The studio and control room (at the upper level, overlooking the studio area) are housed in a new addition at the rear of the present location in downtown Wilkes Barre.

the first of their kind. And recently station engineers installed two of the first TR-22 transistorized tv tape recorders, completing an up-to-date equipment complement.

Color Operation

Early in the game, WBRE-TV management recognized the potential of color tv—and the station became the first in the area to be completely equipped for color operation. The station carries the full schedule of NBC network color programs. In addition, they originate a schedule of local and film shows. They are equipped for production of live, film and tape color commercials.

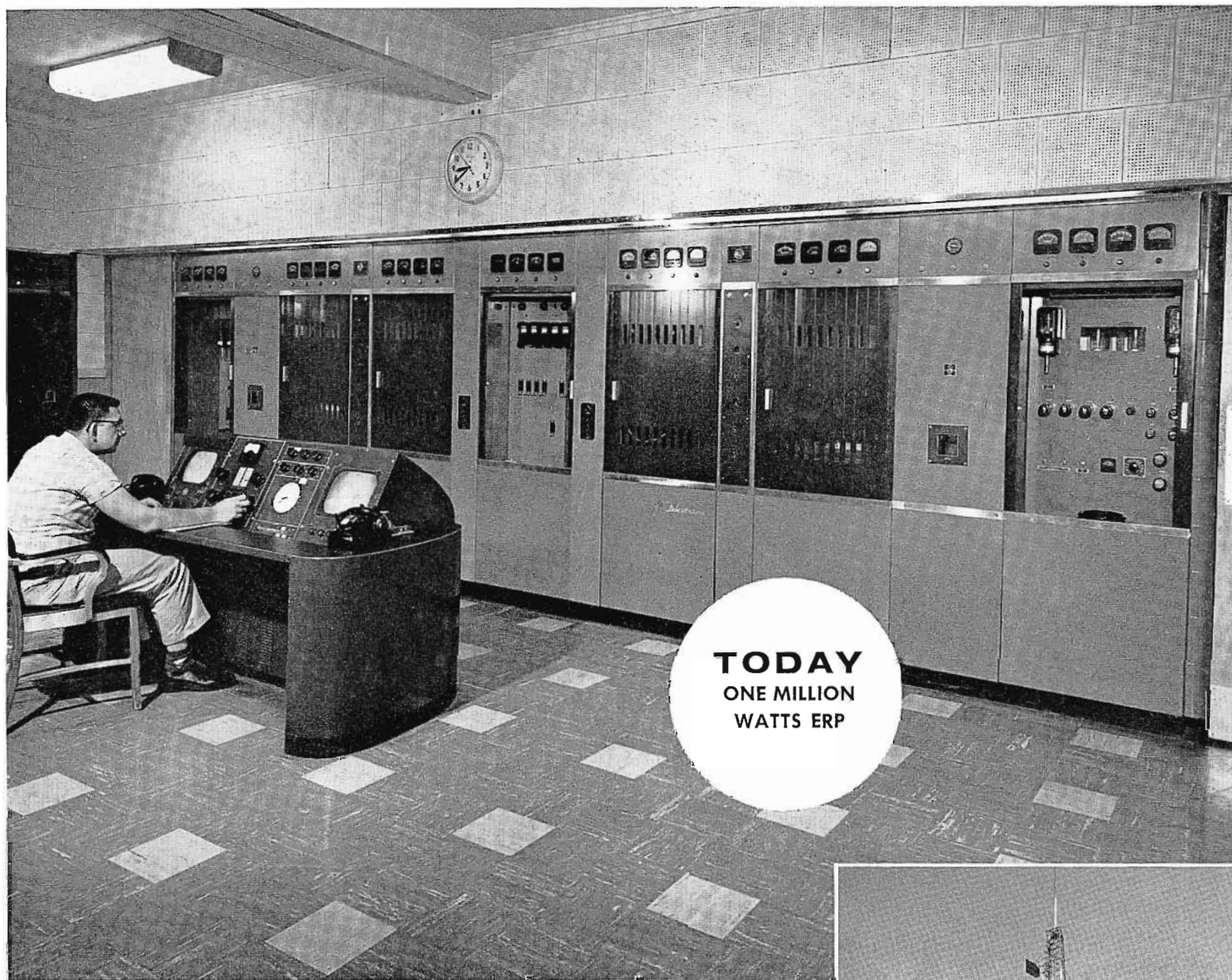

FIG. 2. TTU-25B UHF transmitter is the source of one million watts erp.

RCA's FIRST 1-KW UHF TRANSMITTER GROWS . . . TO ONE MILLION WATTS ERP

It has been "RCA all-the-way" for WBRE-TV as they have progressed from their very beginning to one megawatt operation. The station first went on-air with 17 kw erp peak visual power obtained from the first *production* Type TTU-1B, 1-KW UHF Transmitter and UHF pylon antenna on New Years Day, 1953. On July 31, 1954, the station began operating the first TTU-12A, 12½-KW amplifier which was added to their original TTU-1B.

The next step in a UHF power increase program was the addition of a TTU-25A amplifier and a TFU-46AL ultra-gain antenna (with a power gain of nearly 50). This combination resulted in one-million

watts erp—which was first put into operation on January 1, 1955.

Today WBRE-TV operates at one megawatt erp using their TFU-46AL antenna and TTU-25B amplifier which has replaced their earlier 25A equipment.

Photos on these pages illustrate the steps the station has taken in their progressive expansion to high power. Each view was taken from the same corner of the transmitter room. Amplifiers were added to the basic UHF driver with a minimum of alteration, since an inside partition had been planned from the beginning to accommodate high power equipment. While the partition has been modified several times,

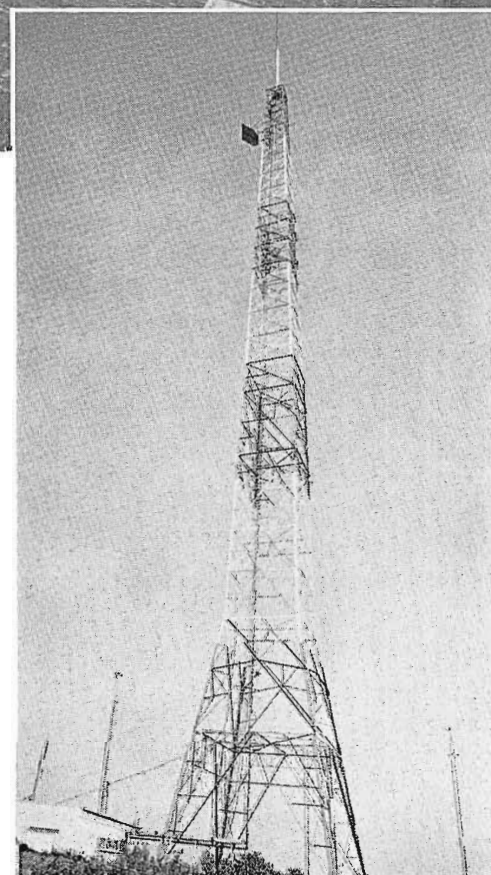

the basic floor plan of the building has gone unchanged—it is the same today as it was when first constructed to house FM transmitting facilities.

Each new power increase at WBRE-TV has been achieved without loss of air time. This is due for the most part to very careful advance planning. Plans for television operation were begun as early as 1947 when WBRE-FM was being constructed.

With the guidance of RCA engineers, the station planned the FM transmitter build-

ing to accommodate future television transmitter equipment. The FM tower was also designed to television requirements and was installed in 1947 at much less expense than an equivalent tower today. These early provisions have allowed the station to install their necessary new equipment with only minor building and tower modifications.

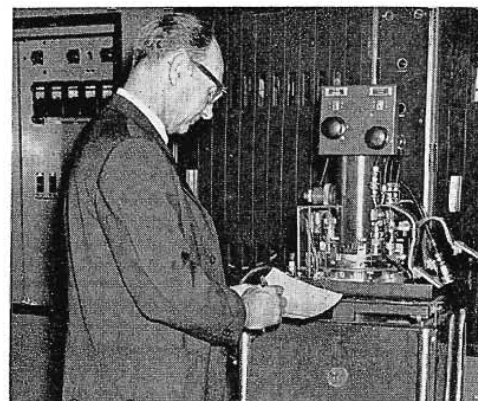

FIG. 3. Record tube life of 40,221 hours is logged on the 6806 tetrode in the final stage of TTU-25B amplifier. This is one of the stations original UHF tubes.

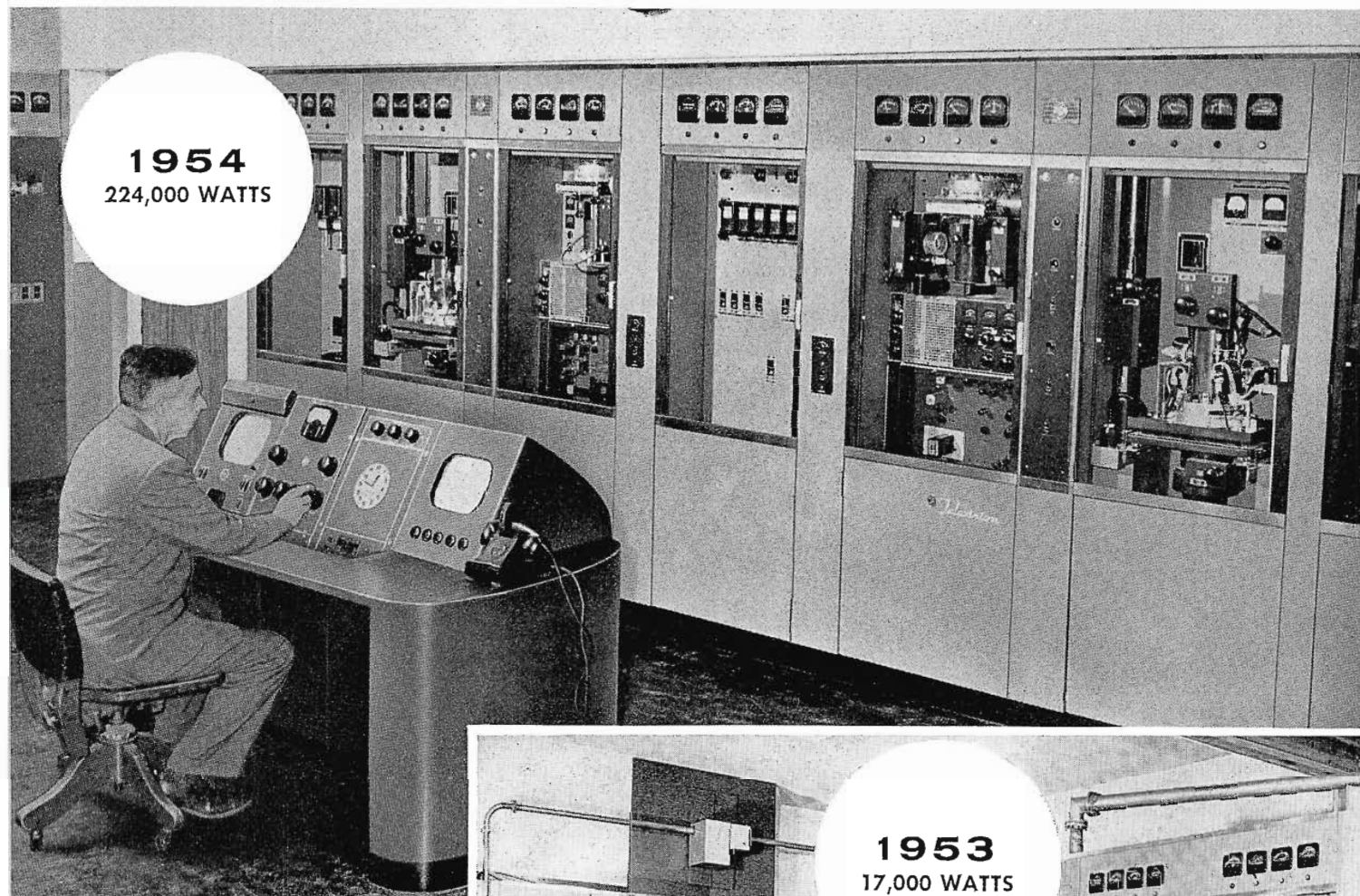

FIG. 4. WBRE-TV transmitter room in 1954 shows a newly installed TTU-12A UHF amplifier. Effective radiated power at this time was 224,000 watts.

FIG. 5. TTU-1B transmitter went on-air January 1, 1953 at WBRE-TV's present transmitter site. This original transmitter serves as a driver for today's 25 kw equipment.

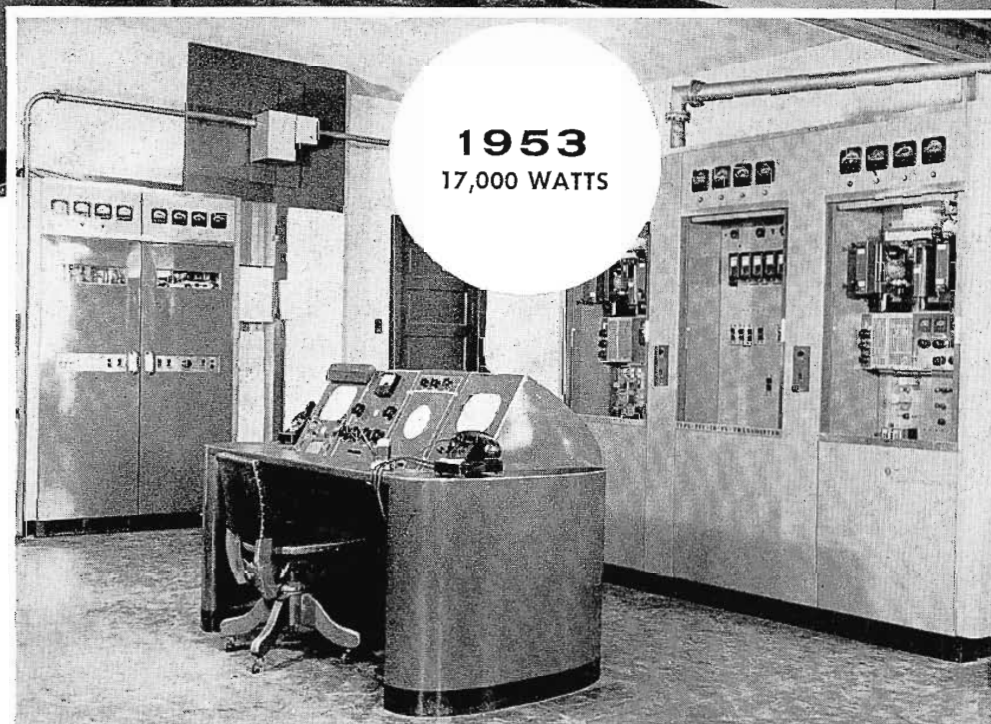

FIG. 6. Ultra gain pylon atop 380-foot self-supporting tower. The tower was built in 1947 to mount FM antenna — planned to accommodate future TV operations.

SPACIOUS NEW STUDIO . . . EQUIPPED FOR COLOR AND MONOCHROME

The studio plan at WBRE-TV is both spacious and simple. The L-shaped arrangement occupies 3000 square feet. This provides room to house a number of permanent sets for both color and monochrome programs. The spacious studio quarters makes possible any number of local program types—from full-orchestra and chorus musical shows to audience participation programs. For the latter, the studio can accommodate 300 or more people.

In a recent program more than 200 United Fund workers were served dinner

in the studio, as part of a Fund telecast.

Studio production facilities include a 20-foot diameter turntable built into the floor. This is capable of displaying as many as four automobiles. Drive-in access to automobiles is provided through overhead doors at the corner of the studio (see floor plan below). Built-in rear screen projection facilities are installed between the studio and prop storage area at the rear of the building. This is a permanent facility—available at any time to clients. Should the need arise, over one hundred yards of cur-

tain—encircling the entire studio—can be pulled into place to cover sets and provide a new studio atmosphere.

Camera equipment includes two TK-11 monochrome studio cameras and one TK-41 color studio camera. The color camera is equipped with zoom lens for production flexibility and is used on such regularly scheduled local live shows such as the daily "Kitchen Magic" productions and the Saturday evening news. The photos on the facing pages show studio areas in which permanent sets are left standing.

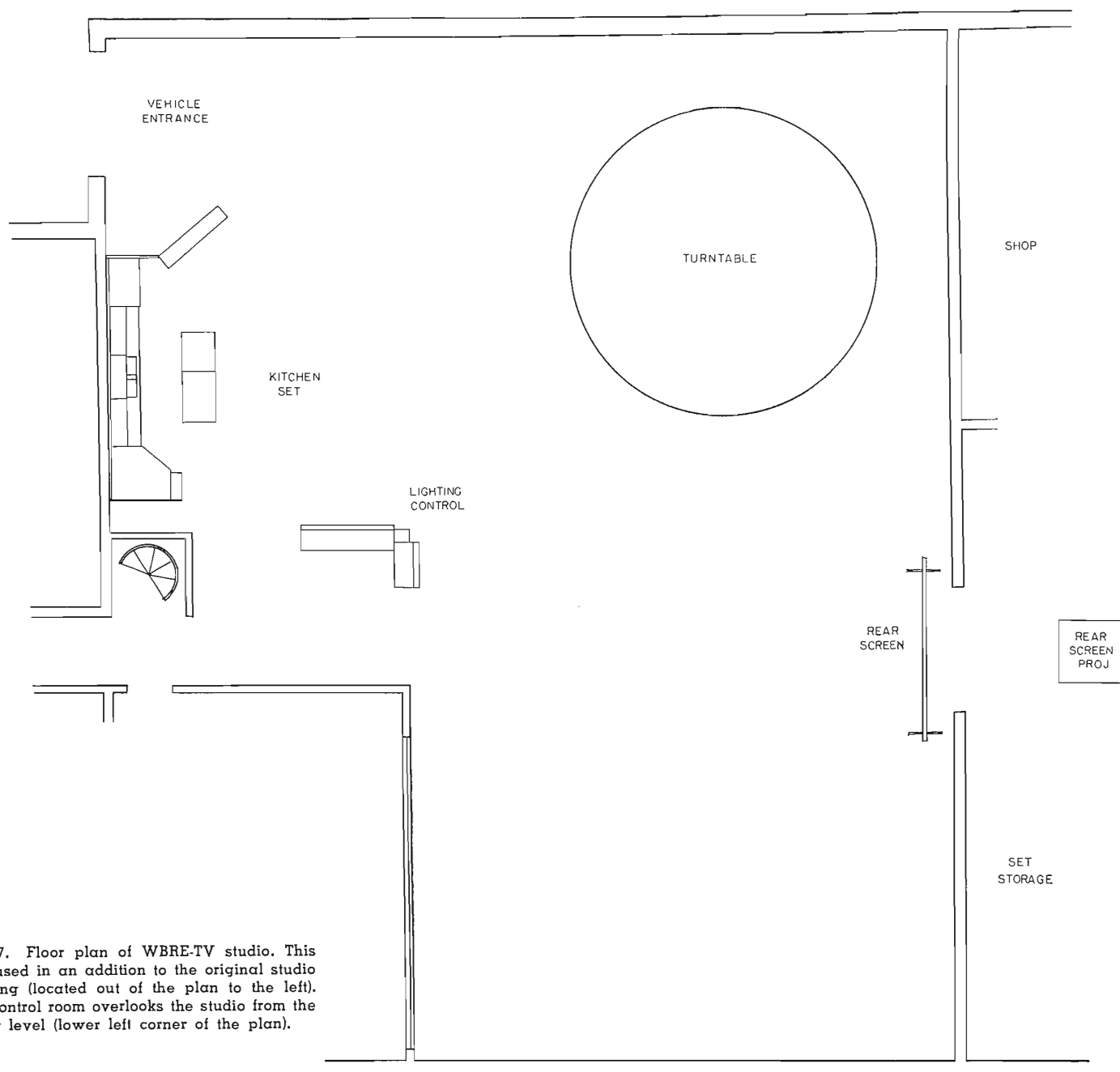
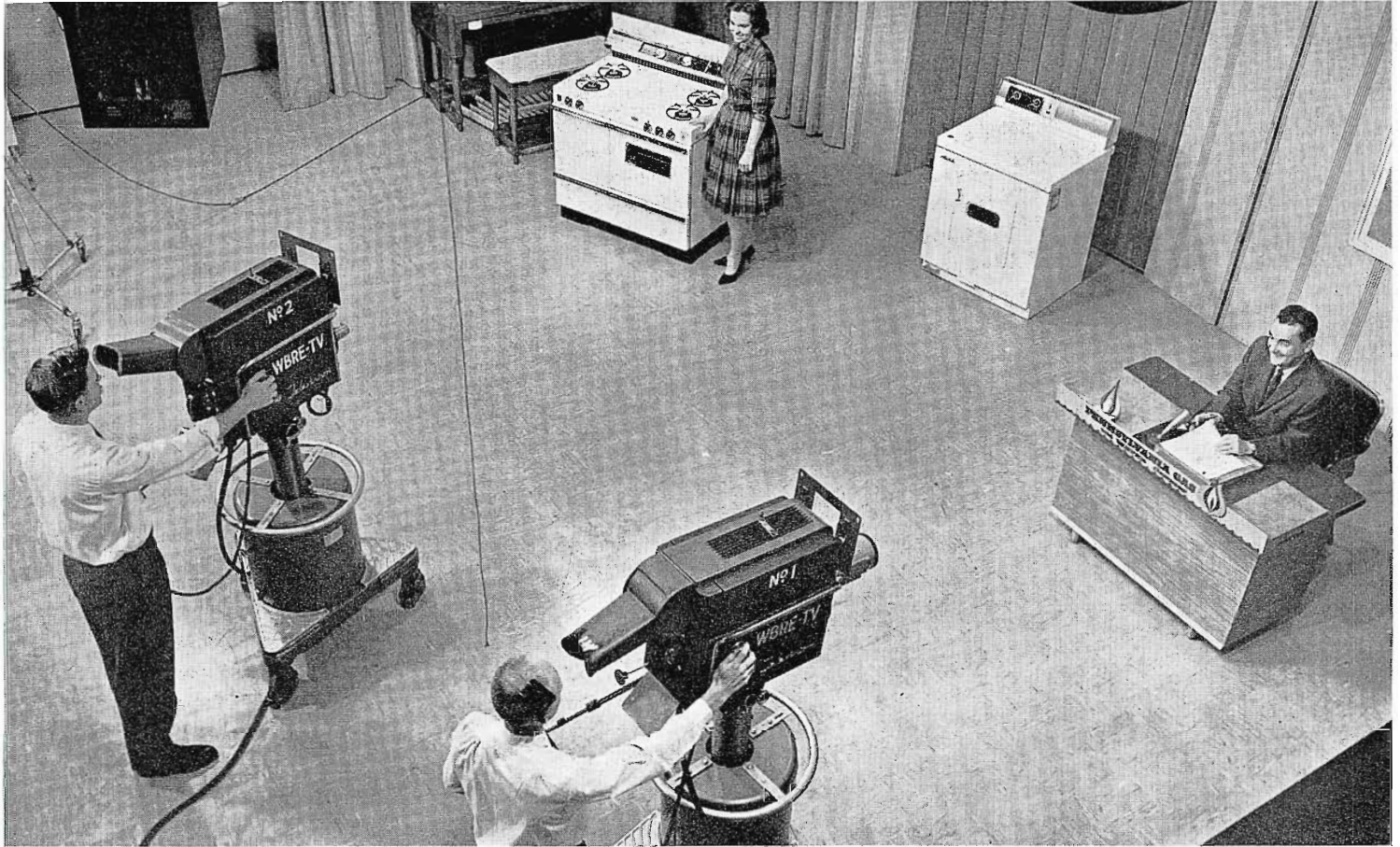

FIG. 7. Floor plan of WBRE-TV studio. This is housed in an addition to the original studio building (located out of the plan to the left). The control room overlooks the studio from the upper level (lower left corner of the plan).



▲
 FIG. 8. Monochrome cameras are trained on news and appliance commercial settings in the area of the studio shown in the lower portion of the floor plan.

▼
 FIG. 9. A permanent kitchen set, located in the upper left portion of the floor plan, is the originating point for "Kitchen Magic" a regular color offering.



**A MODERN LOOK FOR
MASTER CONTROL
. . . HIGH EFFICIENCY
EQUIPMENT GROUPING**

The complete complement of color and monochrome camera control, switching, station-break automation, master control, film and slide origination equipment, and tv tape recorders have been installed in this highly-efficient equipment grouping (see floor plan below).

The layout groups equipments by function, placing them all in a single area. Advantages of this arrangement include simplified operations, maximum utilization of station-break automation techniques, picture quality improvement through the use of short cable runs, and simplified integration of both color and monochrome operations.

Ten Years of Service

The guide to progress at WBRE-TV has been efficiency—efficiency in operation and efficiency in execution of their UHF plan. By careful consideration of future requirements, by up-dating facilities, and by installing the most modern of tv equipment, WBRE-TV has provided its viewers the best possible television service for more than 10 years.

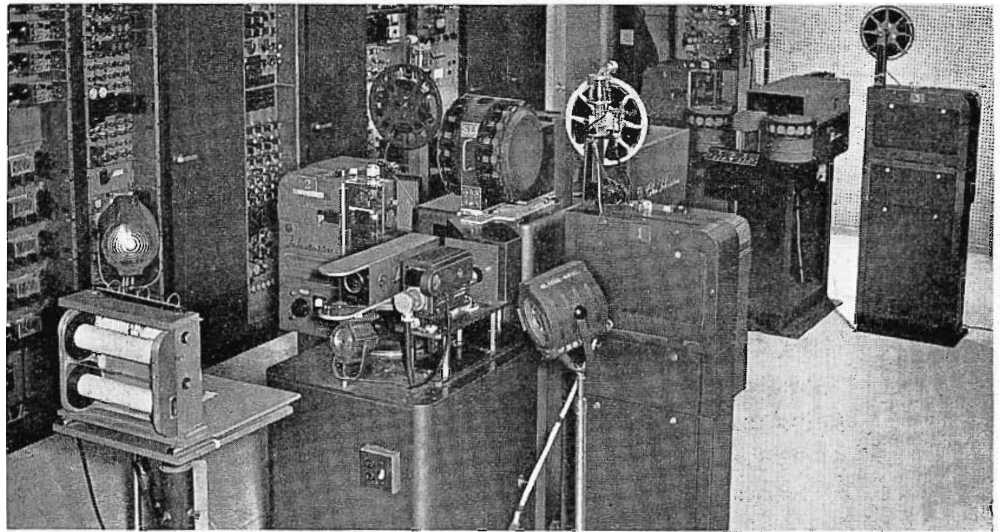

FIG. 10. Color film grouping includes all equipment necessary to originate color films, slides and opaques. A TP-15 multiplexer accommodates TK-26 color film camera, two TP-6 16-mm film projectors, TP-7 dual-drum 2 by 2 slide projector and opaque attachment.

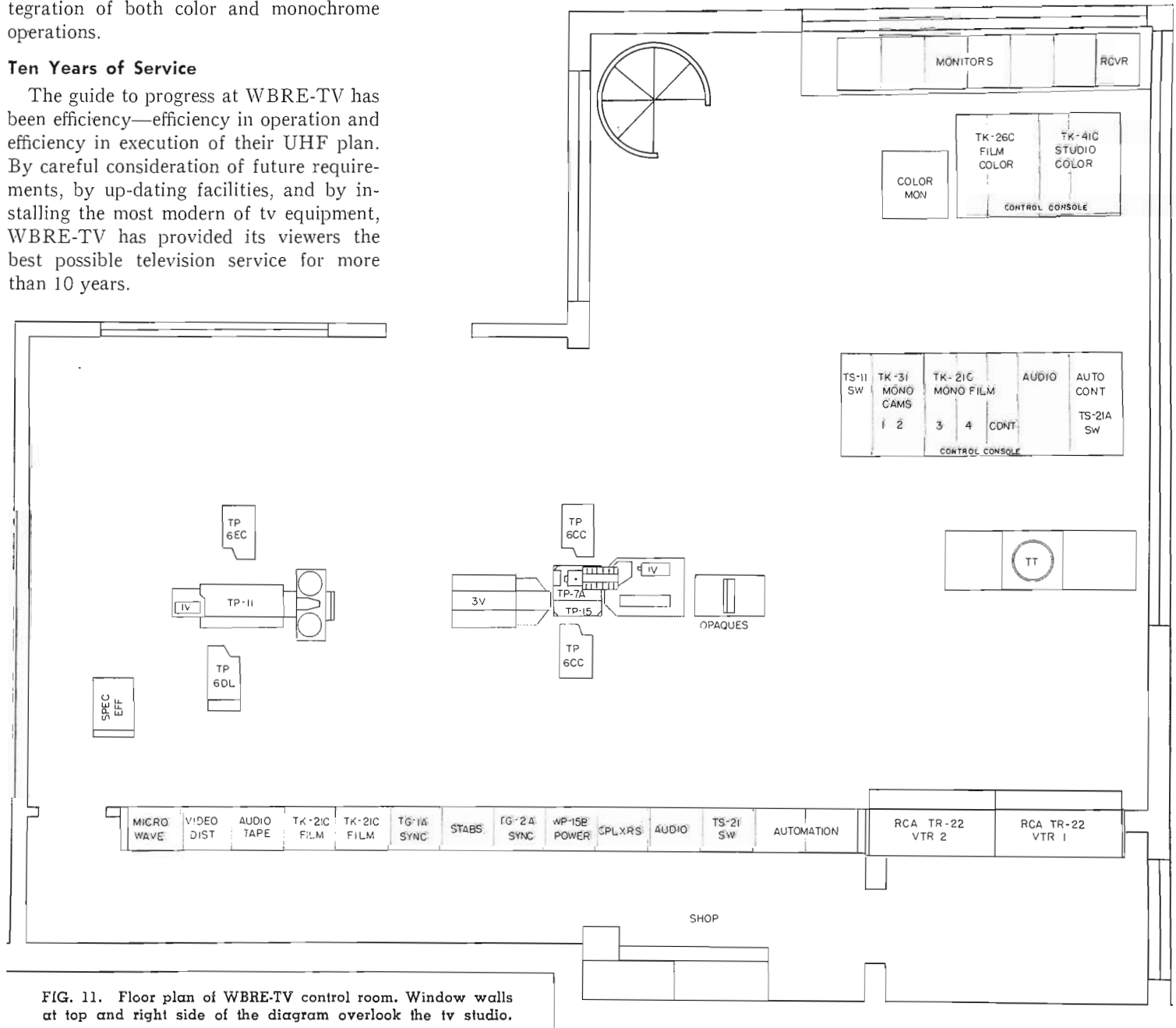
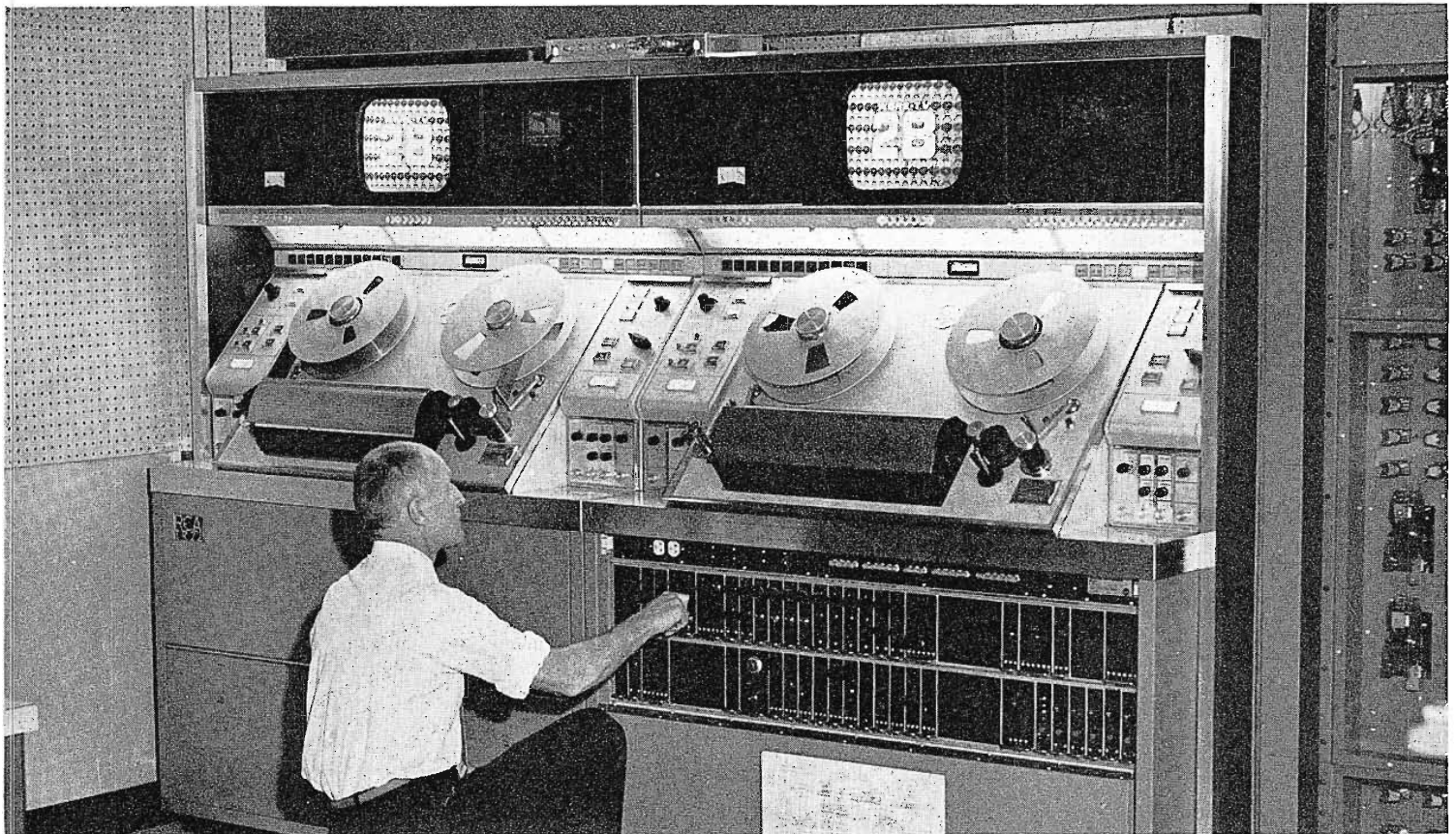

FIG. 11. Floor plan of WBRE-TV control room. Window walls at top and right side of the diagram overlook the tv studio.



▲ FIG. 12. Two new TR-22 transistorized tv tape recorders, recently installed in the control area. These two compact units are self-contained tv tape recording facilities—require no external racks.

FIG. 13. Camera and master control facilities—color camera control (back) and monochrome camera control and switching (foreground). An automation system handles up to 10 events for station-breaks.



THE RCA ONE-KW UHF TRANSMITTER

The TTU-1B also Serves as Driver for
12.5, 25 and 50-Kw Transmitters

FIG. 1. The TTU-1B UHF-TV Transmitter. Completely self-contained in three cabinets. Control in center, aural transmitter at left, visual at right.

The one-kilowatt TTU-1B is specifically designed to fulfill the needs of broadcasters for a transmitter of reasonable price with top-grade performance in either color or black-and-white programming. It is an all-air-cooled, self-contained transmitter that, when used with a suitable antenna, provides up to 50 kilowatts of effective radiated power.

Design Permits Expansion Without Obsolescence

This transmitter is an excellent facility for the budget broadcaster in that it provides a means to start broadcasting at minimum investment in equipment and technical manpower. As the broadcaster's market increases, he can add increased transmitter

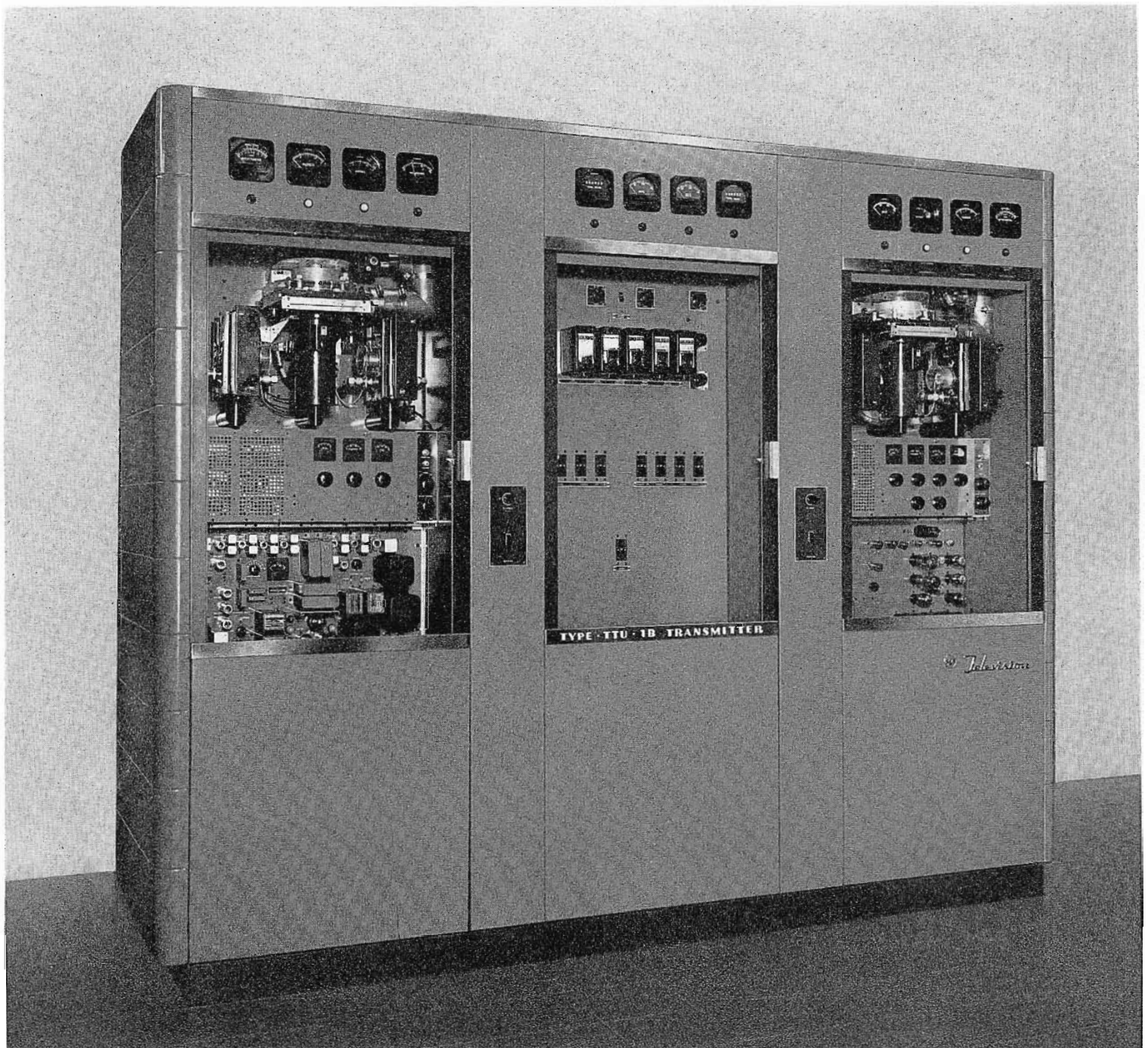

power without obsolescence of his original transmitter by adding a 12.5, 25 or 50-kilowatt power amplifier to the 1-kw transmitter. Coupled with suitable antennas such as the UHF Pylon, a 50-kw facility can provide a power level of 2 megawatts ERP.

Modern Design Features Simplicity and Economy

The circuits used in the TTU-1B employ the kind of design features that result in operational simplicity, long life, dependability and economy. The transmitter delivers the ultimate in picture fidelity, black-and-white or color.

Complete in Three Cabinets

The TTU-1B Transmitter is housed in three sliding-door cabinets. These include everything except the filterplexer and harmonic filter.

The center cabinet contains the control switches, relays and circuit breakers which allow separate operation and provide overload protection for the aural and visual amplifiers. A single cooling-air blower, mounted on the bottom of the center cabinet, draws air through a filter in the rear and pushes it to the various tubes and components in the other cabinets. Incidentally, the blower is the only rotating element in the transmitter.

The right-hand cabinet contains the visual transmitter—from exciter to final amplifier—employing the highly dependable and long-lived Type 6181 tetrode as the final amplifier.

The left-hand cabinet houses the aural transmitter, which—except for the modulator—is a virtual duplicate of the visual transmitter. This design feature is deliberate for two important reasons: one, it reduces the transmitter's complexity and thereby its original cost and, second, it simplifies maintenance in that personnel gain a quicker and better understanding of the unit. A third, and considerable, reason is that this design reduces the investment in spare parts because one piece of inventory serves two or more functions.

Designed for Growth

The TTU-1B UHF-TV Transmitter is the ideal choice for the just-starting broadcaster in that it provides high-quality transmitter facilities at minimum initial investment, minimum operating cost and maximum life. Since the TTU-1B can serve as the driver unit of a 12.5, 25 or 50-kilowatt final amplifier at a later date, it prevents premature obsolescence of the 1-kw transmitter.

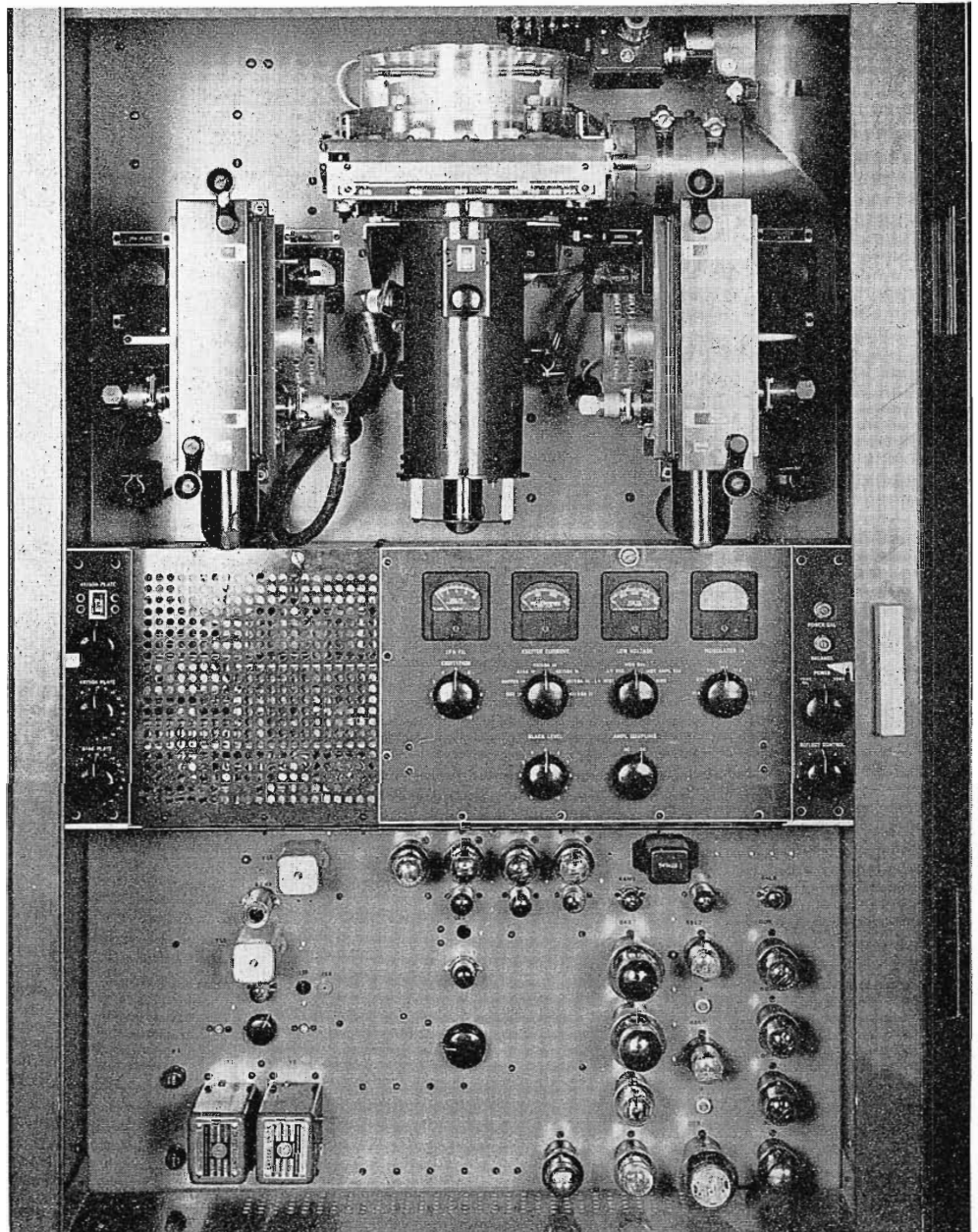
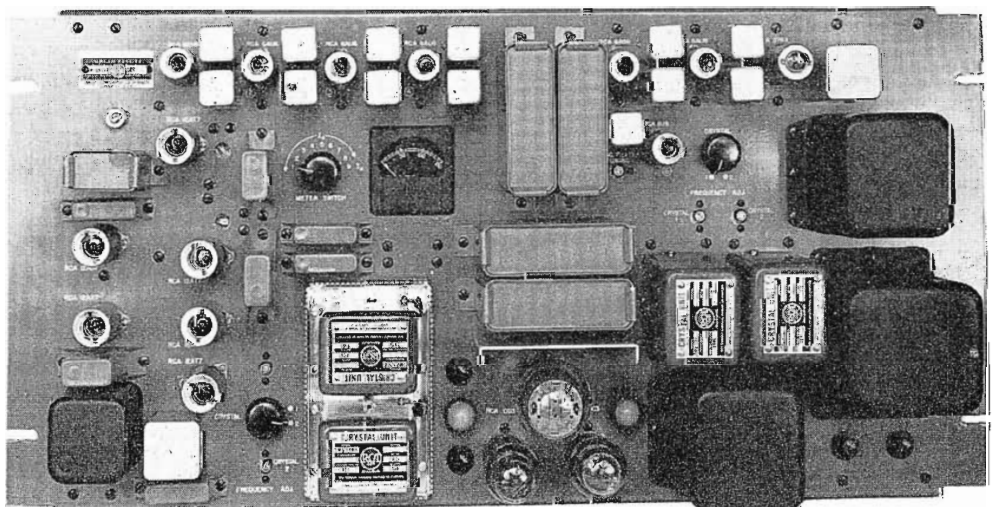

FIG. 2. Close-up of visual-transmitter panels.

FIG. 3. Aural transmitter exciter panel.



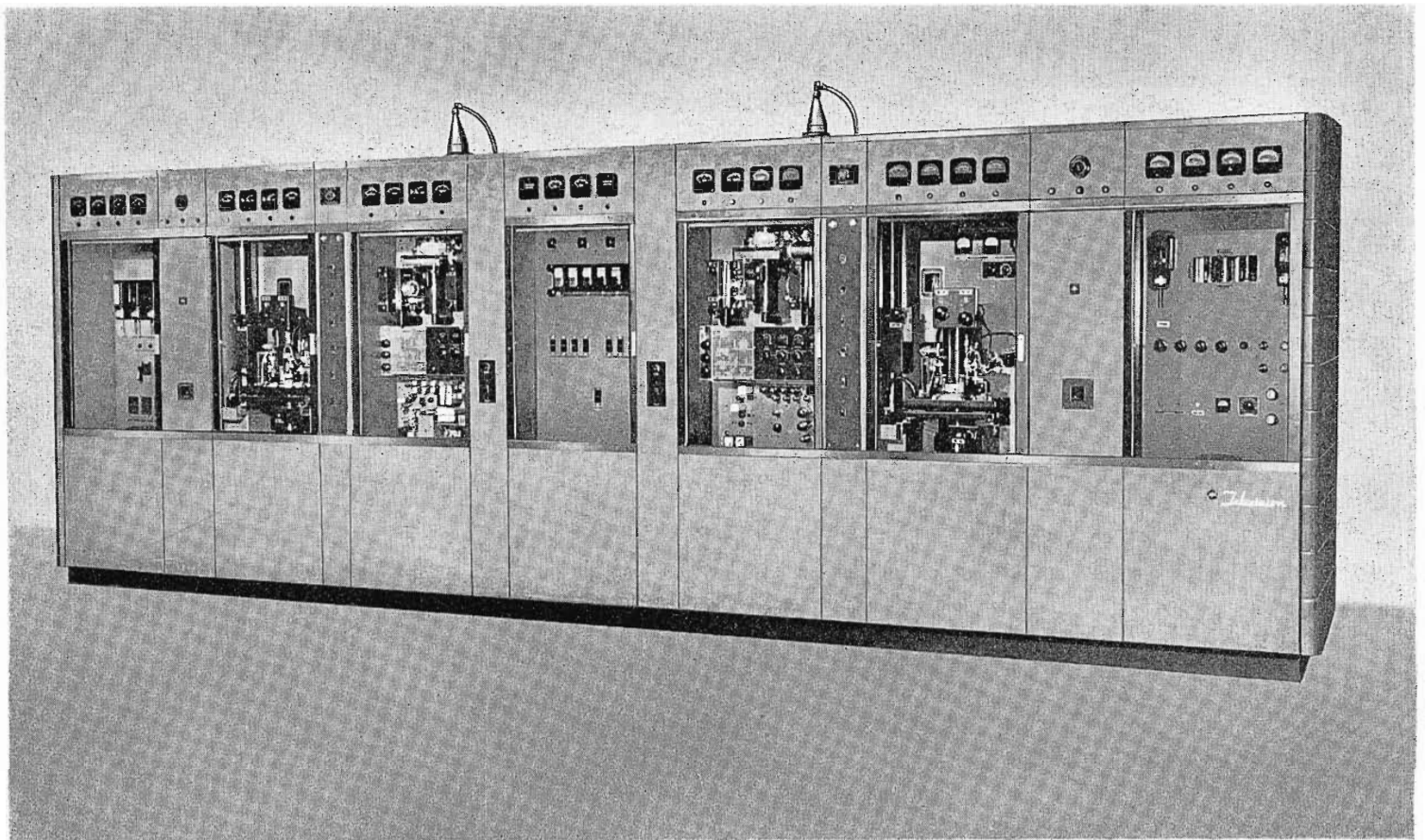

FIG. 1. The TTU-12A and TTU-25B UHF-TV Transmitter. The 12.5-kw transmitter is field expandable to 25 kilowatts without an increase in occupied floor space.

RCA 12.5 AND 25-KILOWATT UHF TRANSMITTERS

Building-Block Design Permits Power Increase Without Equipment Obsolescence

The RCA medium-power UHF transmitters—Types TTU-12A and TTU-25B—are designed for television broadcasters whose markets are too large for a 1-kw transmitter but not yet large enough for a 50-kilowatt system. Since these transmitters use the same mechanical configuration, the 12.5-kw system is field-expandable to a 25-kw facility.

The TTU-12A and TTU-25B are available to the industry in two forms: with or without the exciter/modulator/driver system (the three center cabinets). Thus, a broadcaster using a 1-kilowatt system may add-on 25-kw amplifier to his existing facility to significantly reduce the financial outlay for the expansion.

In terms of effective radiated power, a 12.5-kw transmitter is capable of 50 to

400 kilowatts ERP; a 25-kw transmitter, 275 to 1000 kilowatts ERP, depending on several factors: transmission-line length, antenna power gain and the channel number assigned.

Single-Line Cabinet Layout

Figure 1 shows the TTU-12A Transmitter with its sliding doors open. The three cabinets in the center of the group contain the exciter, modulator and driver-amplifier stages of the transmitter. These are identical to the 1-kw TTU-1B transmitter. The two-cabinet groups either side of the center three comprise the aural and visual power amplifiers and their associated control equipment.

The cabinets at the far left house the aural amplifier and the main control panel

for the power amplifiers. At the right-hand end is a cabinet that contains an auxiliary control panel with the visual-amplifier cabinet separating it from the driver group in the center.

The 25-kilowatt TTU-25B Transmitter uses the same mechanical configuration as the 12.5-kw system. The difference between the two is the tube type used in the final amplifiers, 6448's serving the TTU-12A and 6806's in the TTU-25B.

Tetrode Final Amplifiers

Considering the power capabilities of the 6448 and 6806 tetrodes, they are small in size and extremely rugged. Figure 4 indicates their size as compared to a man's hands. The same tube type is used in both the aural and visual power amplifiers (6448

in the 12.5-kw and 6806 in the 25-kw). The tetrodes operate as part of a concentric cavity which reduces the number of tuning controls to only two—this, of course, greatly simplifies amplifier tuning when tube-replacement time comes around. To further simplify tube change, the amplifiers are supplied with one spare cavity and two power-amplifier “carriages”. One of these is shown in Fig. 3. This equipment permits the change of an entire cavity rather than just the tube to result in two important advantages: one, it allows very-quick change in the event of tube failure during air-time and, second, the spare cavity becomes portable and easily handled.

12.5-Kw Field Expandable to 25-Kw

The imaginative design of the TTU-12A permits field expansion—without mechanical changes—to double the power output. This power increase requires only a change in tube type (6448 to 6806) in the aural

and visual amplifiers (the tube types are mechanically interchangeable) and an increase in power supply high voltage (merely a change in transformer connections). Thus, without an increase in occupied floor space, a 12.5-kw transmitter becomes a 25-kilowatt facility.

Silicon-Rectifier High-Voltage Power Supplies

The TTU-12A and TTU-25B Amplifiers are equipped with silicon rectifiers in the plate and screen supplies. The virtually limitless life of these rectifier devices increases the reliability of the amplifiers several notches in that the arc starvation, temperature sensitivity and arcbank tendencies of vapor-type rectifiers are completely eliminated.

Field Expandable Without Forfeit

These UHF-TV transmitters are designed with field expansion in mind yet, the design forfeits none of the performance,

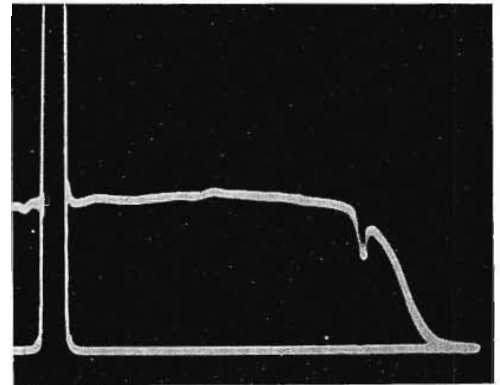

FIG. 2. TTU-12A or TTU-25B video-frequency response before filterplexer. Marker 4.2 mc above channel 44 carrier.

reliability and longevity for which RCA transmitters are famous. The substantially identical circuitry in the aural and visual portions contributes much to the ease of maintenance and operation as well as significantly reducing the idle investment in spare-parts inventories.

FIG. 3. Power amplifier “carriage” in use during cavity change. The carriage allows very quick cavity change and easy handling.

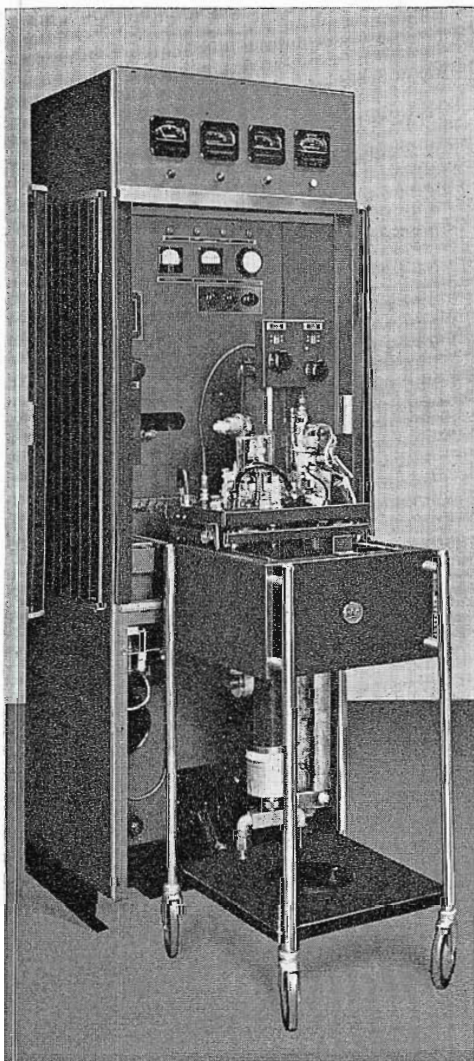

FIG. 4. The UHF Tetrode (6448 or 6806). Considering its power capabilities, this tube is small in size and extremely rugged. Installed in this transmitter, the tube becomes part of a concentric cavity with only two tuning controls.



This article describes the 50-KW TTU-50A Television Transmitter designed and built by RCA for the series of UHF color and monochrome propagation tests recently conducted in New York City.

While the basic design of the new transmitter closely follows well-established concepts employed in lower power RCA UHF transmitters there are certain features of the TTU-50A that broadcast engineers may find of special interest particularly at this power level.

For example, with an RCA high gain antenna the TTU-50A achieves an effective radiated power of two million watts. All tuned circuits—including the driver—are peaked for resonance, permitting simple but accurate tuning. Visual hum level is low enough to insure satisfactory operation on non-synchronous network originations.

From the standpoint of conservative design, the transmitter, which is water-cooled, utilizes conventional tetrodes in the high power amplifier stages, providing at the output of the filterplexer a full 50-kw visual and 25-kw aural signal. Transmitter bandwidth capability is 7.5 mc for the visual amplifiers and 6 mc for the aural. Total power consumption is approximately 100 kilowatts for average conditions.

Equipment Layout

Transmitter equipment, including rectifiers and control circuitry, is contained in sliding door cabinets arranged in an "open-U" configuration. Four of these cabinets (containing the rectifiers, thyratron units and PA power supplies) form the right wing of the transmitter assembly; a matching left wing contains the main and auxiliary controls for the entire transmitter. Cubicles and compartments are identified in the diagram of the front line cabinets (Fig. 4). This is a floor plan layout of the transmitter proper, control console, overhead-mounted waveguide filterplexer, plate transformers and water cooling equipment.

RF Circuitry

The exciter for the TTU-50A transmitter is the RCA one-kilowatt UHF transmitter Type TTU-1B, a design that has had wide acceptance (since its introduction) not only as a reliable low power UHF transmitter, but as a driver for the RCA 12- and 25-kw amplifiers.

The visual output of this transmitter provides the necessary power to drive an intermediate power amplifier to about 3 kw. This in turn drives two diplexed RCA-6806 high power amplifiers for a combined visual output of 50 kw. In the

aural channel, the output of the TTU-1B is sufficient to drive a single RCA-6806 amplifier to the required 25 KW aural power.

The TTU-1B is an all air-cooled equipment designed for both color and monochrome operation on Channels 14 to 83. Except for circuitry in the very low level stages, the aural and visual r-f sections are identical. Final aural and visual amplifiers each utilize a single RCA-6181 which in the case of the visual section is high level modulated.

PA Tube and Resonant Cavities

The power amplifiers for the aural and visual sections of the transmitter are identical except for additional broadbanding circuitry employed in the visual amplifiers. Each power amplifier utilizes a tuned grid and plate cavity assembly made possible by the coaxial construction of the RCA-6806 power amplifier tube itself. The coaxial cavities, which are identical for all power amplifiers, are assembled directly above and below the tube, with the two tuning controls—one for the grid

cavity and one for the plate cavity—accessible for easy tuning while the transmitter is under power. The entire unit is arranged on a "glide-in" shelf to provide simple installation and interchangeability. Only one set of cavities is required to tune the entire UHF band.

Grid Cavity

The grid cavity is a $\frac{3}{4}$ -wave resonator, about one-half of which is within the 6806 tetrode. External to the tube is a low-impedance coaxial element which is an adjustable section for tuning the cavity to resonance. Power from the preceding stage is capacitively coupled to the grid cavity at a point of higher impedance (about 50 ohms). Broadbanding of the cavity in the visual amplifier is accomplished by absorbing a small portion of the driving power in a resistive load.

Plate Cavity

The plate cavity is a half-wave coaxial resonator, the first quarter-wave of which is mostly within the tube. The second quarter-wave portion is utilized for tuning

RCA 50 KW UHF TRANSMITTER

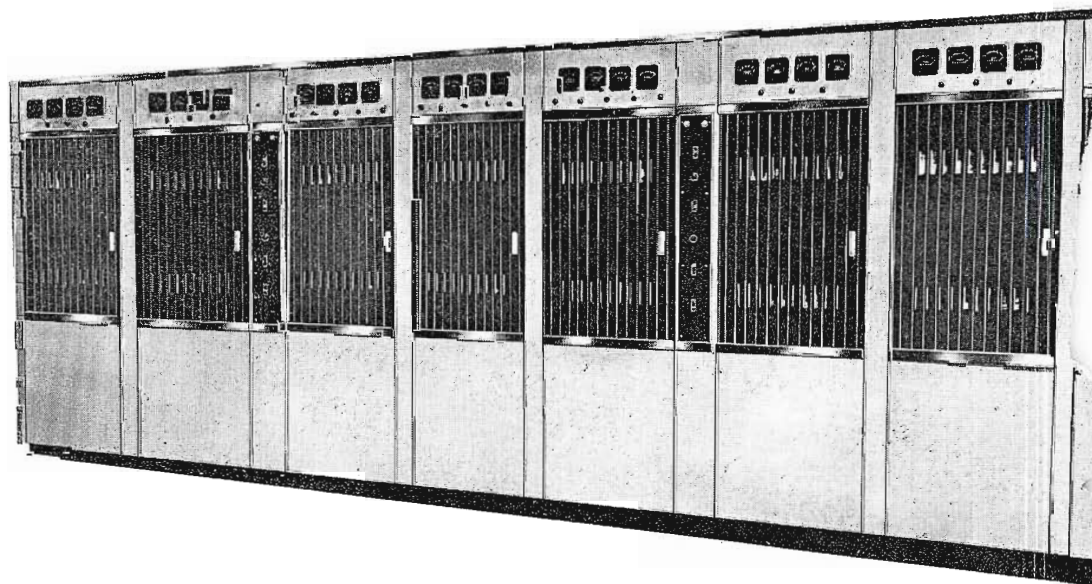

FIG. 1. Type TTU-50A 50-KW UHF Television Transmitter. With a high gain antenna can achieve effective radiated power of two million watts.

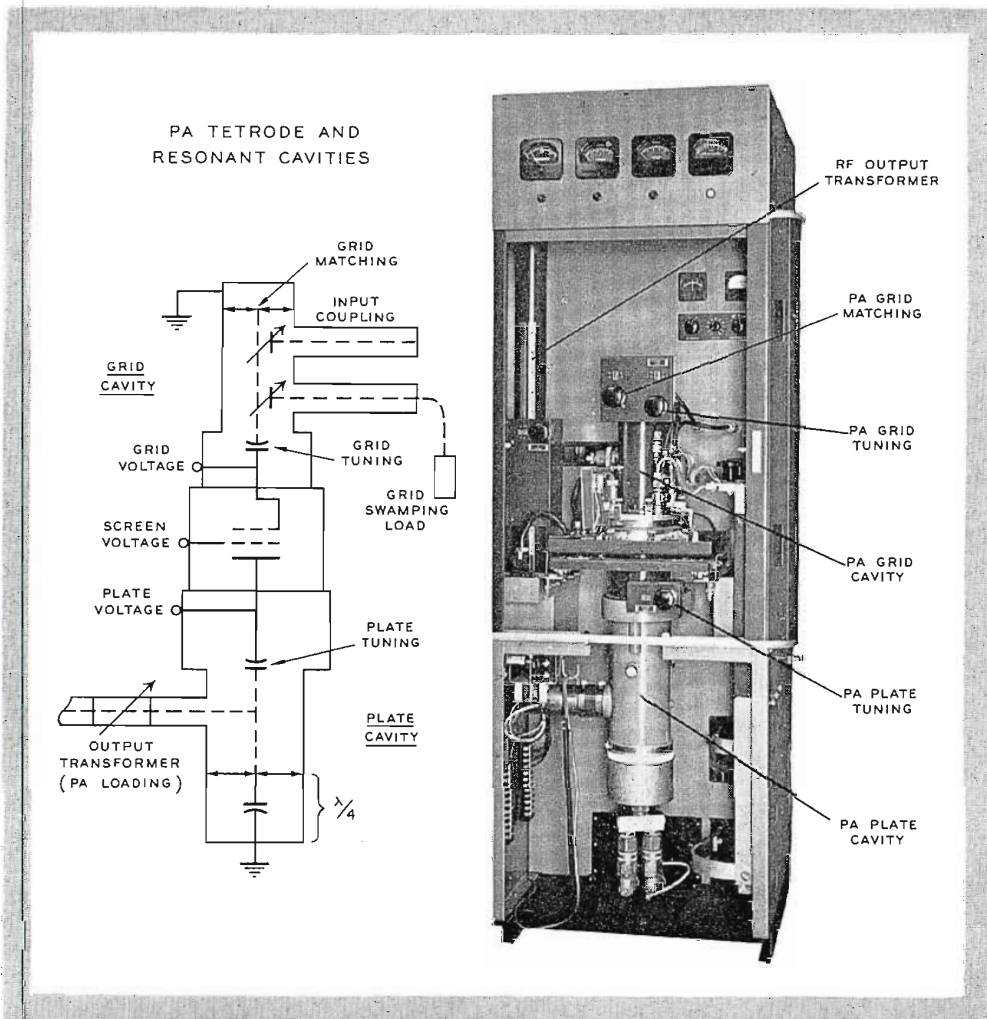

FIG. 2. PA cabinet (right) showing RCA-6806 tetrode and tuning cavities. Simplified schematic (left) of PA tube and resonant plate and grid cavities.

by the proper positioning of a short, low-impedance section within the cavity. This element not only serves to tune the cavity to resonance, but by virtue of its low impedance, also reduces circulating current in the cavity so that broadbanding is obtained without stagger tuning.

Assembly Connections

PA tube and cavity assembly can be installed with ease and in only a few minutes time. Connections to the assembly are completed by attaching five snap connectors for water, three filament leads, and the r-f input and output connections; screen grid voltage is automatically connected when the PA cavity is slid into place. A single multi-conductor plug simultaneously completes the interlock and filament volt-meter connections, and a special heavy-duty union permits rapid connection of r-f output power.

RF Output Transformers

Each high power amplifier is coupled to its load by an r-f output transformer mounted within the amplifier cabinet. This transformer presents to the amplifier an adjustable, resistive r-f load impedance which in effect controls the bandwidth of the resonant output circuit. Since bandwidth is proportional to loading, once the transformer has been adjusted for a given frequency and bandwidth, no further adjustment is necessary.

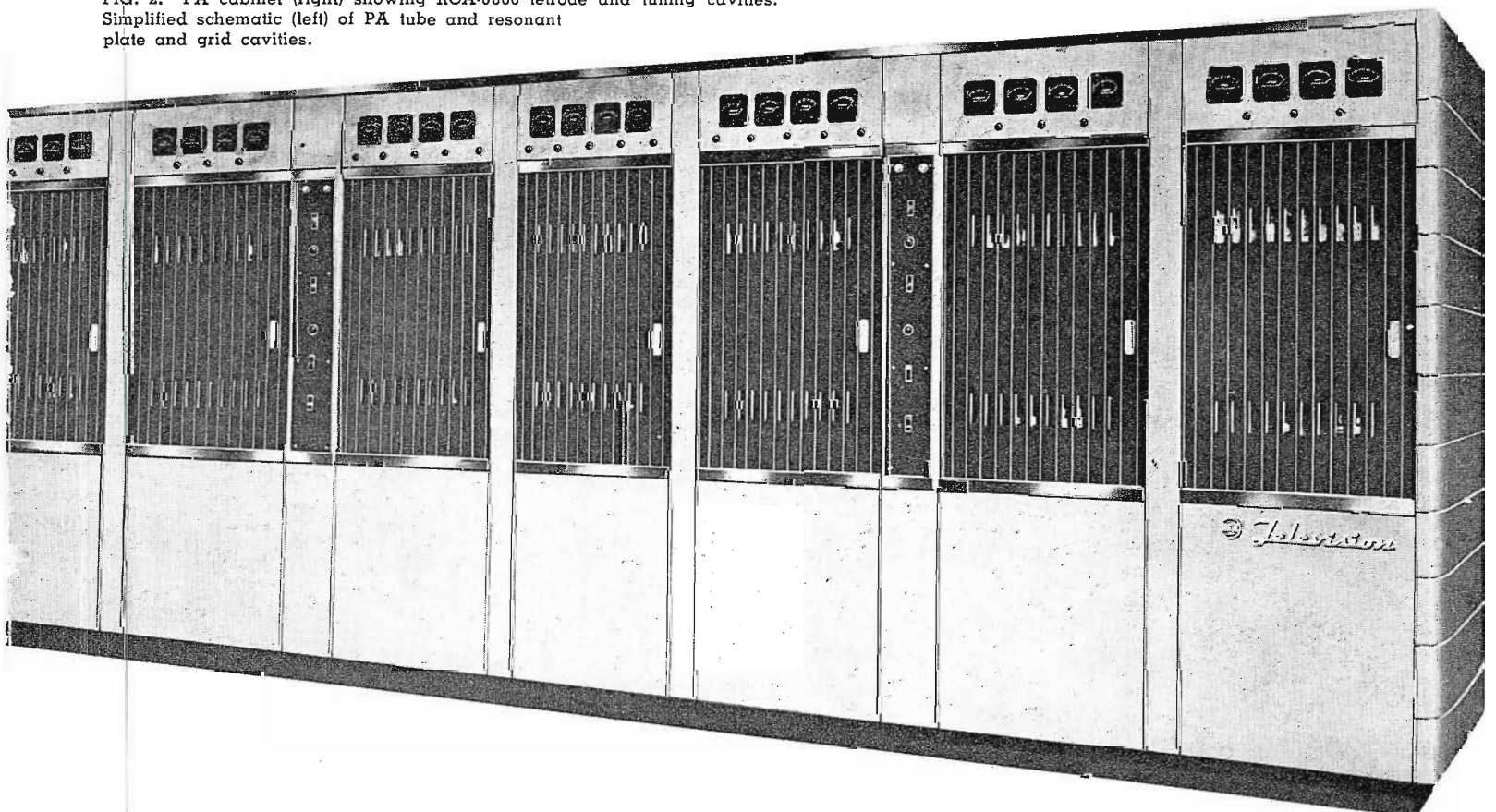

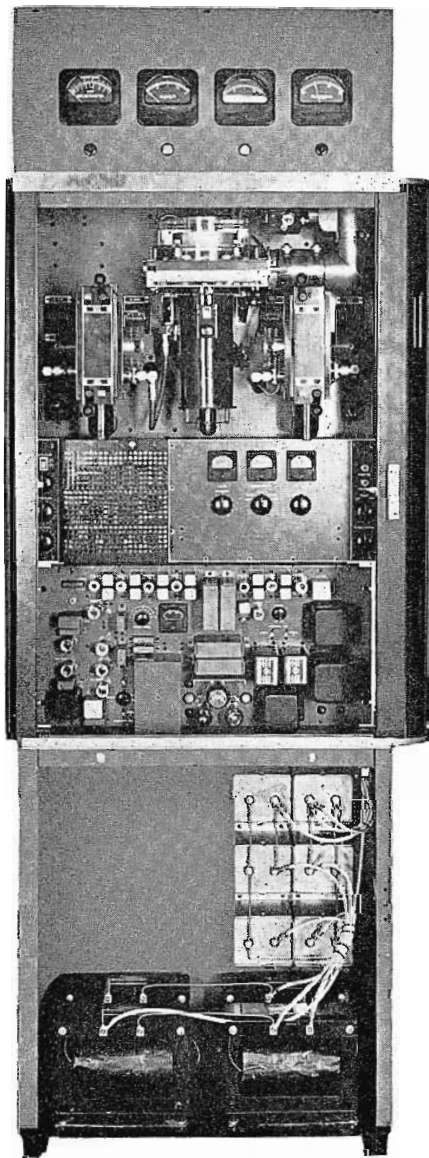

FIG. 3. R-F circuits of the 1-KW Driver.

Basically, the transformer consists of a length of coaxial line containing two quarter-wave elements attached to external rack and pinion mechanisms which permit the elements to be moved up or down the line. A control geared to the racks permits the transformer to serve as an impedance match and/or bandwidth control. The elements (or slugs) are cylindrical metallic shells a quarter-wave long at the operating frequency. The diameter of the elements is chosen so as to change the characteristic impedance of the coaxial line to a given value over the length of the slug. Slug physical length may be changed for a specific operating range.

Identical transformers are used in the aural and visual amplifiers.

Diplexers

Power output from the visual IPA is fed to the two visual high power amplifiers

through a power splitting diplexer. The diplexer is a fixed tuned section of coaxial line which maintains the correct phase, amplitude and balance of the signals fed to the two high power amplifiers. Similarly, the outputs of the two high power amplifiers are fed to a second diplexer which combines the outputs to produce 50 KW visual power.

Diplexing provides a large measure of isolation between the two grid circuits and the two plate circuits of the paralleled amplifiers, permitting the tuning of either stage with only minor reaction in the other.

In the coaxial line sections feeding the intermediate and high power amplifier stages, are adjustable telescoping sections of line. These "line stretchers" provide adjustment of electrical line length for optimum impedance match, video response and minimum reflected power between stages.

FIG. 4. Floor plan layout for TTU-50A UHF TV Transmitter.

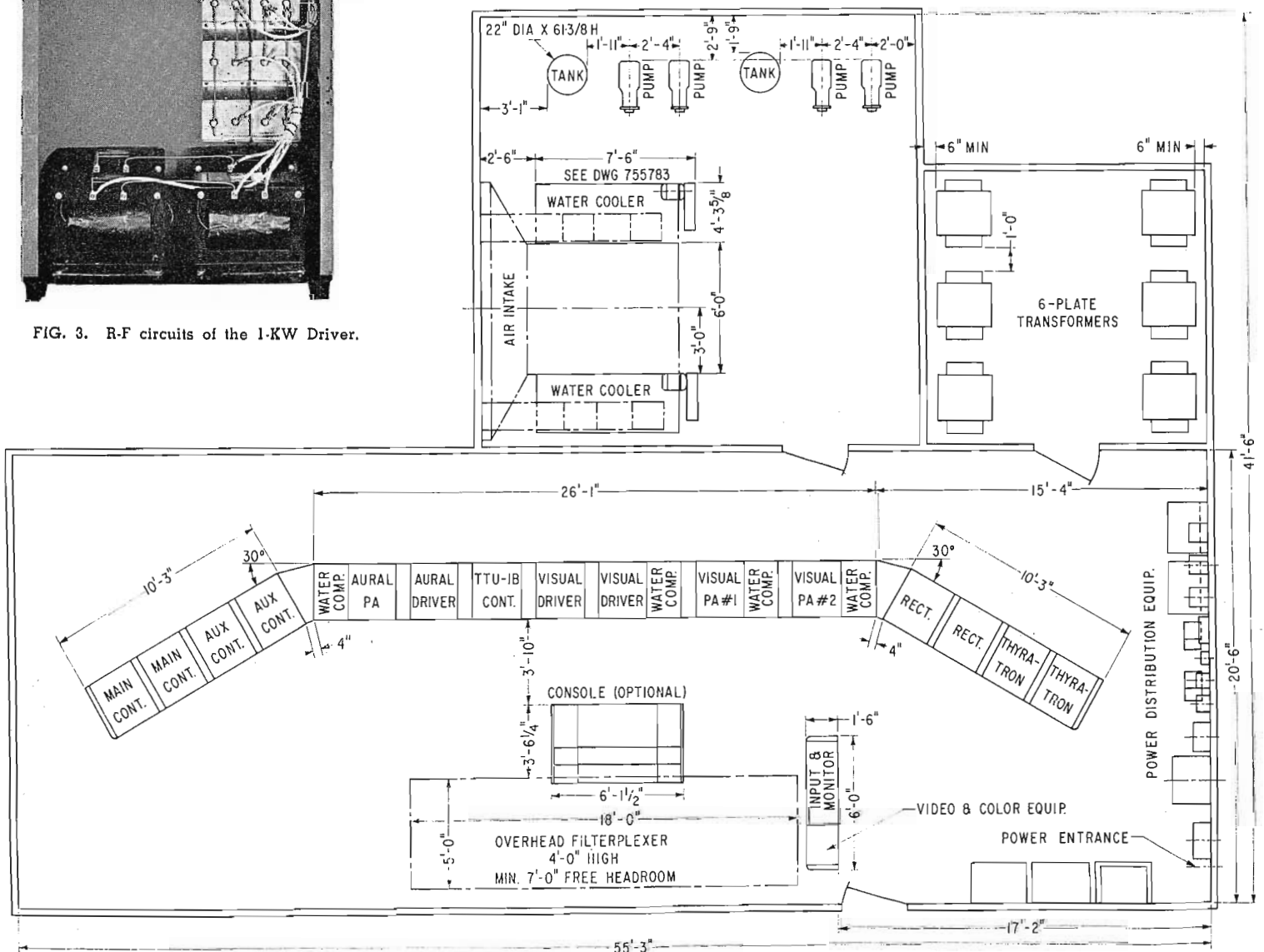

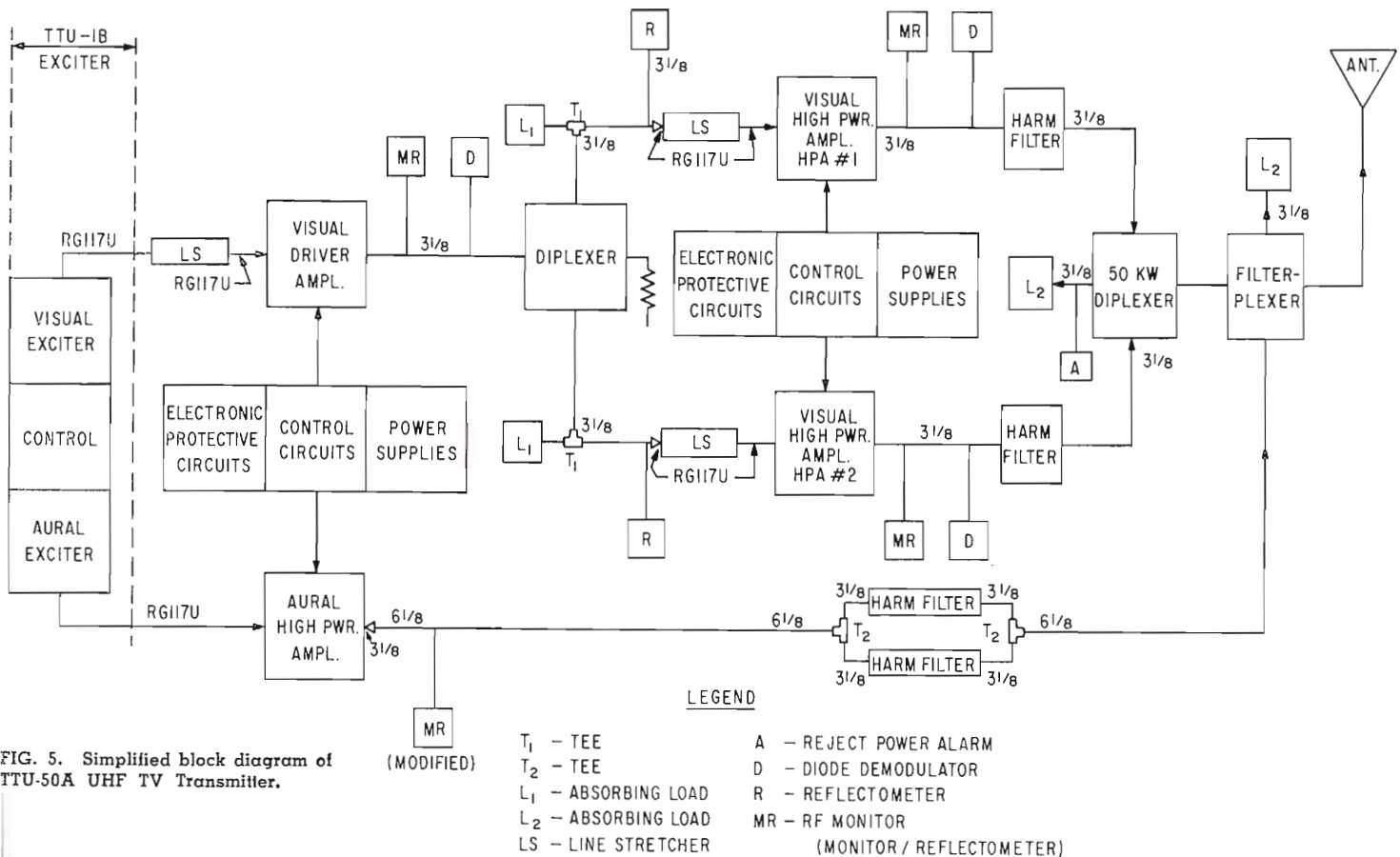

FIG. 5. Simplified block diagram of TTU-50A UHF TV Transmitter.

Filterplexer

The filterplexer, a device made available with all RCA TV transmitters, serves the dual purpose of a diplexer and vestigial sideband filter inasmuch as it combines the aural and visual transmitter outputs and suppresses the undesired sideband. It can be ceiling mounted and thus saves transmitter room floor space.

In the TTU-50A transmitter, a waveguide type filterplexer is used. The design for this unit was completed some time ago when RCA first reviewed various approaches to high power UHF equipment; but it was not used in lower power transmitters since the original spherical and cylindrical designs were less expensive and were adequate for the lower power levels.

The new waveguide type filterplexer handles the combined 50 KW visual and 25 KW aural powers without need for pressurizing or forced-air cooling. Invar steel construction is used wherever necessary to compensate for temperature changes and thus maintain constant frequency control. Aural and visual input connections are standard flanged $6\frac{1}{8}$ -inch, 75-ohm, for ease of connection to the transmitter. Output flanges are $9\frac{3}{16}$ -inch for connection to high power coaxial transmission line.

Power Supplies and Cooling

Plate voltage for the TTU-50A transmitter is produced by two power supplies, each providing 8000 volts for the plates of the power amplifier tubes. Separate low voltage supplies are used for the screens and control grids.

One set of these power supplies and a water cooling system is common to both the visual IPA and aural high power amplifier: the diplexed visual high power amplifiers operate from the second set of power supplies and a separate water-cooling system.

Two sets of 3 air-cooled, steel encased plate transformers connected for 3-phase operation eliminate the need for a concrete transformer vault.

Protective Circuits

In addition to the usual transmitter protective circuitry, electronic overload protection removes plate and screen voltage from power amplifier tubes in the event of a temporary tube fault. This is a high speed device developed during the design of the RCA $12\frac{1}{2}$ -KW UHF transmitter, and results in greatly extended tube life. By its use, power amplifier tubes are relieved of short circuit burden in less than ten microseconds after the fault occurs.

The complete control circuit of the TTU-50A was designed especially to permit flexibility of operation. All control functions are monitored, and all principal circuits are metered. Included are the most modern and effective interlocking systems for equipment protection and personnel safety.

Electrical performance and stability characteristics of the TTU-50A high power UHF transmitter more than meet the requirements of FCC and EIA standards for color and monochrome transmission.

Extends Power Increase Design

The TTU-50A represents the latest addition to a wide range of power outputs obtainable on UHF channels beginning with the RCA TTU-1B one kilowatt transmitter. Mechanically as well as electrically, the 12-, 25- and now the 50-KW designs provide a logical and economical means for low power stations to satisfy an immediate but perhaps previously unforeseen need for extended television coverage with a minimum of investment.

As in the case of the 25-KW UHF transmitter, the TTU-50A offers the possibility of operation at half normal power output, if desired, by simple equipment changes and deletions.

RCA SERVICE

keeps all your
AM, FM, TV
equipment
in top
condition!



Amplifier Overhaul

Your audience demands a superior signal which requires top performance from all your station equipment. RCA Broadcast Service is planned

to assure you of meeting this objective. More than 30 years in the broadcast industry have provided a background of solid service experience.

TAKE ADVANTAGE OF THE FOLLOWING SERVICES OFFERED BY RCA:

- Video Tape Recorder Service • TV Camera Overhaul • Installation Supervision
- Microphone and Pick-Up Repairs • Transmitter Performance Measurements
- Antenna Inspection Measurements • Console Repairs • Microwave Service
- TV Projector Service • Custom Fabrication

This is the type of protection broadcasters have relied on for years, the kind of protection you can count on . . . contract or per-call . . . from the experts in the service business, RCA Service Company. To guard performance of all your equipment . . . simply telephone one of the

following field offices: Atlanta (phone 799-7291), Chicago (WE 9-6117), Camden (GL 6-7984), Hollywood (OL 4-0880). Or contact Technical Products Service, RCA Service Company, A Division of Radio Corporation of America, Bldg. 203-1, Camden 8, N.J.



The Most Trusted Name in Electronics

RCA-6448 AND -6806 BEAM POWER TUBES

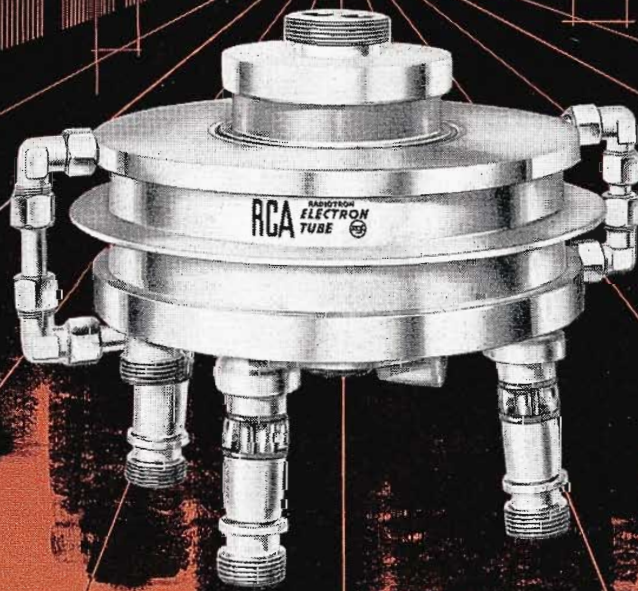

The Tetrode Power behind UHF-TV transmitters

THE TUBES THAT MADE UHF-TV PRACTICAL. Today, the majority of "on-air" UHF-TV transmitters—operating in the range from 470 to 890 Mc—use RCA-6448's and -6806's in grid-driven power amplifiers. They are the industry's champion beam power tubes for reliable, high power UHF-TV.

In installations from coast to coast, UHF telecasters know that the output power and high efficiency of these tubes remain essentially the same as they were on the first day of installation. Some broadcast engineers report tube costs of less than 35 cents per hour. Telecasters get low-cost operation with RCA-6448's and -6806's on any UHF-TV channel.

These tetrode designs incorporate a coaxial electrode structure, ceramic-metal seals, and thoriated tungsten filaments. This kind of advanced technology makes them highly versatile tubes for use in black-and-white or color TV.

The appeal of long life and low cost operation per "on-air" hour has placed RCA-6448's and -6806's in the forefront of UHF-TV power tubes with the majority of station owners.

FOR FAST SERVICE ON THESE TYPES CALL YOUR RCA DISTRIBUTOR OF BROADCAST TUBES

RCA ELECTRON TUBE DIVISION, HARRISON, N. J.

The new edition of RCA TRANSMITTING TUBES (TT-5) has been extensively revised and contains data on over 180 tube types. It includes maximum ratings, characteristics, typical operating values, and power-tube circuit-design considerations, as well as tables for quick, easy tube selection. Also included are circuit diagrams for transmitting and industrial applications and new design information on linear rf amplifiers for single-sideband service. Available from your RCA Electron Tube Distributor or RCA Commercial Engineering.

Optional List
Price: \$1.00

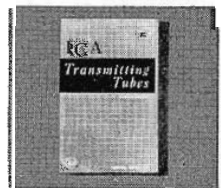

The Most Trusted Name in Electronics



THE MOST
TRUSTED
NAME IN
TELEVISION